



Battery life investigation of a hybrid energy management system considering battery temperature effect

Pouriya Rahimirad, Masoud Masih-Tehrani, Masoud Dahmardeh*

¹School of Automotive Engineering, Iran University of Science and Technology, Tehran, Iran

ARTICLE INFO

Article history:

Received : 30 Jan 2019

Accepted: 06 Mar 2019

Published: 01 Jun 2019

Keywords:

Battery life,
Hybrid energy storage systems,
Power distributions, Thermal
model,
Energy management

ABSTRACT

This paper works on the effect of temperature on a hybrid energy storage with different energy management systems. The hybrid energy storage system consists of a fuel cell, ultracapacitor and battery with DC/DC and DC/AC converters. The energy management strategies employed are the state machine control strategy, fuzzy frequency/logic decoupling strategy, minimization strategy of equivalent consumption (ECMS) and external energy maximization strategy (EEMS). Initially, a module of 3.3v 2.3Ah LiPo4 batteries consisting of 15 cells in series and 15 rows in parallel are studied without considering the temperature effect. In the next step, the studies are repeated considering the temperature variation effects. The current and SOC associated with the battery, the hydrogen consumption, and battery life are studied for each strategy. The results suggest that the errors associated with the battery life estimation, as well as the battery current are significant with and without considering the temperature effects with the values of 30% and 20%, respectively.

* Masoud Dahmardeh

1. Introduction

Fuel cell vehicle is the way to improve efficient and environmentally friendly transportation systems. [1] Electrical power from fuel cell is high efficiency, less emission and noise. Battery and the super-capacitor is the way to store energy and help to provide demanded power. [2]

The battery life model is for J. Wang from "Cycle-life model for graphite-LiFePO₄ cells" paper. [3] LiFePO₄ (iron and lithium phosphate) is used a lot in HEV (hybrid electric vehicle) applications because of its good performance with low cost [3] However, the capacity discharge behavior, the modeling of the life and aging mechanisms is shown in this paper from model of J. Wang. [4][5] Wang et al. evaluated the aging mechanisms of LiFePO₄ lithium-ion cells. The battery life model that use in this paper is for 2011, but there are a lot of recent paper that use this model. [6][7][8][9][10]

In this paper is used different energy management. State Machine Control is a simple and popular rule-based strategy. The frequency decoupling strategy ensures that the fuel cell provides low-frequency demand. PI controllers is used for setting online for better tracking. In ECMS, the power distribution is determined from the minimization of an instantaneous cost function, which consists of the fuel consumption of the fuel cell system and the equivalent fuel consumption of the other energy sources. In EEMS; the proposed strategy aims to maximize the energy of batteries and super-capacitors at all times while keeping the state of charges of batteries and super-capacitors within their limitation. The energy management strategy is based on the control of the primary performance parameters, such as the state of charge of the battery (SOC), the ultracapacitor voltage, the power demand or the voltage of the DC bus. [11] The energy management strategy is based on the control of the main performance parameters, such as the state of charge (SOC) of the battery, the super-capacitor voltage, the power demand or the voltage of the battery. cc bus. It's used in several papers. [11][12]

The simulation of battery temperature is used in this paper is from Simulink model. Battery temperature is simulated from several equations that explain in next paragraph.

Battery temperature model is used in several papers. [5][13][14] some of this papers are the experimental model that shows the validation of this model.

The purpose of this paper is to examine the battery life in two situations where consider constant battery temperature or battery temperature simulated by the battery model in Simulink to provide an optimal method to control the fuel cell system.

The paper is sorted as follows. Section II battery model III battery life model IV case study: fuel cell hybrid energy management V energy management strategies VI battery life of different schemes in Simulink model. Final section is conclusion.

2. ENERGY MANAGEMENT STRATEGIES

2.1 State Machine Control Strategy

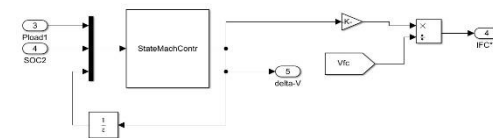

Fig.1. EMS: State machine control

The state control strategy is concluded by some states. These states are derived using some approach proposed in [15]. The power of the fuel cell is calculated by the SOC battery and the load power Pload. The energy management system (EMS) plan is shown in Fig.1. One disadvantage of this approach is switching control requirement when the mode is changed, which effects on the response of this strategy to changes in power demand.

2.2 Classical PI Control Strategy

This strategy is for control SOC of the battery by PI regulator [16], as shown in Fig.2. The output of the PI regulator is P_{bat} (the power of the battery), which is then removed from the P_{load} to obtain the fuel cell reference power. When the SOC is high, the fuel cell power is low and the battery produces its full power. When the SOC is below the reference, the fuel cell provides almost the power of the load. This scheme is simpler compared to previous strategies and obtaining PI on the Internet for better response.

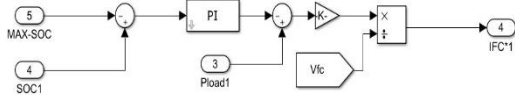

Fig.2. EMS: Classical PI control

2.3 Frequency Decoupling and Fuzzy Logic Strategy

The frequency decoupling and fuzzy logic strategy allow the fuel cell system to produce low-frequency P_{load} , while other high-frequency energy sources match. [17] The primary advantage of this way is the fact that the average battery energy is close to zero, which ensures a narrow range of SOC batteries. However, the fuzzy logic strategy is minimized for controlling battery SOC. Fig.3 is shown the EMS of this strategy. The cut-off frequency is set to 8 MHz from filter, which allows the fuel cell approximately constant. The fuzzy logic controller matches the fuzzy logic strategy.

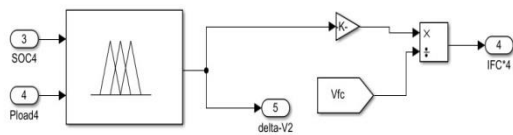

Fig.3. EMS: frequency decoupling and fuzzy

2.4 Equivalent Consumption Minimization Strategy (ECMS)

The ECMS is an optimization strategy based on the well-known instant cost function used by some authors [17][18]. The goal is to achieve minimum fuel consumption in the fuel cell and the equivalent fuel required to maintain the SOC battery. The approach explained in [19] is used in this article where the SOC battery is controlled by the penalty coefficient of the battery energy. The strategy is shown in Fig.4.

The problem of optimization is to find an optimal solution $x = [P_{fc}, \alpha, P_{batt}]$, which minimizes

$$F = [P_{fc} + \alpha P_{batt}] \cdot \Delta T \tag{1}$$

Under the equality constraints

$$P_{load} = P_{fc} + P_{batt} \tag{14}$$

$$\alpha = 1 - 2\mu \frac{(SOC - 0.5(SOC_{max} + SOC_{min}))}{SOC_{max} + SOC_{min}} \tag{2}$$

Within the boundary conditions

$$P_{fcmin} \leq P_{fc} \leq P_{fcmax}$$

$$P_{battmin} \leq P_{batt} \leq P_{battmax}$$

$$0 \leq \alpha \leq 100$$

Where P_{fc} , P_{batt} and P_{load} are respectively the power of the fuel cell, the power of the battery and the power of the load (taking into account the losses of the converter). α is the penalty coefficient, and μ is a constant value. ΔT is the sampling time. P_{fcmin} and P_{fcmax} are respectively the minimum and maximum fuel cell power. $P_{battmin}$ and $P_{battmax}$ are respectively the minimum and maximum battery power. SOC_{min} and SOC_{max} are the minimum and maximum battery state of charges, respectively. The power of the super-capacitor is not taken into account in the optimization problem because the voltage of the DC bus is under control by the battery

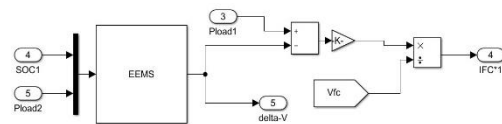

Fig.5. Energy management system: EEMS

converters. That is, as soon as the super capacitors discharge, they are recharged by the same energy source. Therefore, the total charge energy is distributed only between the battery and the fuel cell during a given charge cycle.

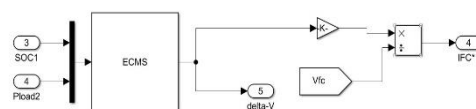

Fig.4. Energy management system: ECMS

2.5 External Energy Maximization Strategy (EEMS)

The proposed strategy aims to minimize fuel consumption by maximizing the demanding energy of batteries and ultracapacitors as part of their operating limitation. The primary advantage of this approach is that the cost function does not need the evaluation of the equivalent battery energy, which is determined empirically. Here, the cost function is simple and is the energy produced by the external power sources during a given time period. The diagram is shown in Fig.5. [20]

The problem is to find an optimal solution $x = [P_{batt}, \Delta V]$ which minimizes

$$G = - \left[P_{batt} \Delta T + \frac{1}{2} Cr \cdot \Delta V^2 \right] \quad (3)$$

Under the inequality constraint

$$P_{batt} \leq (SOC - SOC_{min}) V_{batt} Q$$

Within the boundary conditions

$$P_{battmin} \leq P_{batt} \leq P_{battmax}$$

$$V_{dcmin} - V_{dc} \leq \Delta V \leq V_{dcmax} - V_{dc}$$

Where $|G|$ is equivalent to the maximum external energy in one sampling time. ΔV is the charge/discharge voltage of the super capacitor, and Cr is the nominal capacity of the supercapacitor. V_{dcmin} and V_{dcmax} are respectively the minimum and maximum DC bus voltage. V_{batt} and Q are respectively the voltage and the capacity of the battery. As shown in Fig.6, the outputs of the EEMS algorithm are the reference power of the battery and the charging / discharging voltage of the ultracapacitor. The reference power of the battery is then removed from the charging power to obtain the reference power of the fuel cell. The voltage of the charge/discharge of the ultracapacitor is added to reference voltage of the DC bus to force the ultracapacitor system to charge or discharge. Similar to the ECMS, the DC bus voltage is controlled by the battery converters.

3. case study: fuel cell hybrid energy management

3.1 Battery model

The lithium battery is modeled in MATLAB/Simulink. The battery block runs a dynamic model of the rechargeable batteries.

In addition, the effect of temperature is investigated.

The experimental validity of the model shows a maximum error of 5% (when the SOC is between 10% and 100%) for charging (flow from 0 to 2 °C) and drain (current from 0 to 5 °C) dynamics [5].

Battery life model provides the results of cycling tests from a long-term study on the battery life cycle of a commercial battery lithium battery. The effects of test parameters (temperature, time, depth of charge, rate) were investigated and described. The results indicate that the loss of capacity is mostly influenced by temperature and time, while the DOD (depth of charge) effect is lower at the discharge rate of C/2. The life model is created to describe the dependence of time and temperature on a low discharge capacity range. The public life model for all C-rates is presented by Wang et al. [3] in Equation (4) (Table 1).

$$Q_{loss} = B \exp((31700 + 370.3 * C - rate)/(R * T))(Ah)^{0.55} \quad (4)$$

Which:

- Q_{loss} is the percentage of capacity loss
- B is the pre exponential factor which is dependent on the C-rate which is the ratio of the current of the battery to the capacity of the battery
- R is the constant of the gas
- T is the temperature
- Ah is the Ah-throughput- which is expressed as

$$Ah = (\text{cycle number}) * (\text{DoD}) * (\text{full cell capacity}). \quad (5)$$

The values of B respect to C-rate are listed in Table 1.

Table 1: Values of B respect to C-rate [3]

C-rate	C/2	2C	6C	10C
B values	31630	21681	12934	15512

3.2 fuel cell model

The fuel cell is 7.5 kW, while batteries and ultracapacitors are designed to help in continuous and transient courier demand.

Battery life investigation of a hybrid energy management system

However, for reference, the hybrid system is designed according to the method in [16] and the topology accepted in [21][22] is discussed. Fig.1 shows the simulation of the system shows that 15 parallel and 15 series, 3.3 volt 2.3 Ah mirror with 6 NESSCAP supercapacitors (48.6 and 88 F). [11] The fuel cell system consists of a cellular fuel molecule (PEM) of the 12.5 kilowatt protein (FCPM)

refinery from Hydrogen. As shown in Fig.6, the energy of the fuel cell and battery are controlled by their respective dc/dc converters using an embedded internal controller (NI PXI-8108). The dc/dc converters require a reference voltage of the output and the current reference maximum input/output, which is determined by the energy management system (implemented in the controller).

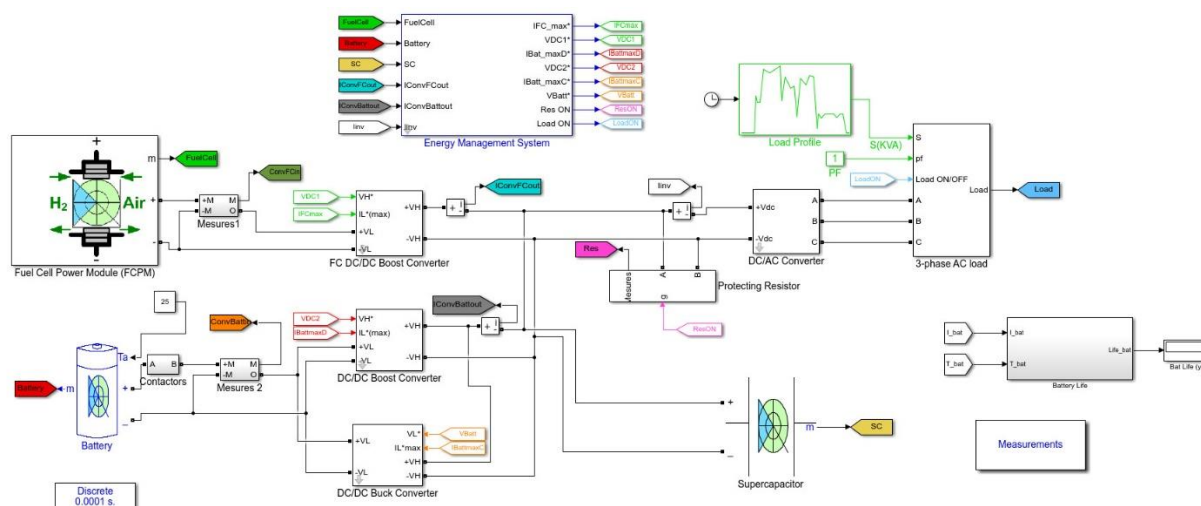

Fig.6. Case study: Example of fuel cell EMS

3.3 Load profile

This load profile is for emergency landing scenario [11]. Load profile consists of two peak load as shown in Fig.7.

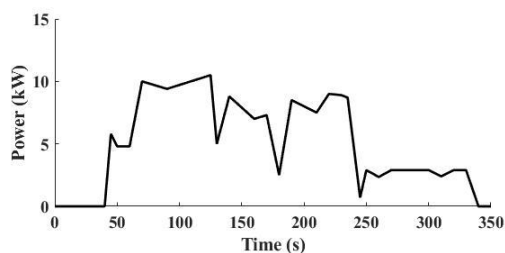

Fig.7. Load profile

4. Results and Discussion

4.1 Battery at a fixed temperature

The model employed in this article is the energy management schemes of a fuel-cell hybrid emergency power system of more-electric aircraft [11] including a battery life model [3].

In this section, the battery life model is assumed to be operating at constant temperature of 25 °C with an initial temperature of 20 °C.

Fig. 8 is shown that state EEMS and PI have maximum average current (21.62 A and 22.27 A, respectively), therefore they have minimum battery life (3.24 years for both). ECMS have minimum average current (8.42 A) and minimum time at peak level, therefore it has maximum life (3.45 years). State machine control and frequency decoupling approximately have same battery current with average current 16.93 (A) therefore it has second rank in battery life.

Fig. 9 shows the battery SOC. At the beginning of the cycle, the battery does not provide any current and is charged by the fuel cell. After 40s, the battery starts to discharge, while it reaches its lowest level of SOC at around 250s. Since the demand power is smaller than the fuel cell output power (4kW and 125kW, respectively), therefore, it has time to charge the battery. As can be seen, ECMS maintains the maximum SOC during the cycle, due to the lower usage of the battery. State machine control, frequency decoupling, EEMS, and PI are at the next levels. The average current drawn associated with these methods are 8.42, 16.63, 16.63, 21.62, and 22.27 respectively.

The current drawn from the ultracapacitor is shown in Fig. 10. The average current drawn from the ultracapacitor for the ECMS, state machine control, frequency decoupling strategies are 1.64, 1.96, 1.96 A. The PI and EEMS methods have the highest current drawn from the UC by 2 and 1.88 A.

The fuel cell current is shown in Fig. 11. The overall hydrogen consumption for the ECMS is increased by 7.5% compared with the PI method (35.72 and 33.04 grams, respectively), while the battery life is improved by 6.16% (3.45 and 3.24 years, respectively). This is due to larger average current drawn from the fuel cell for the ECMS strategy (152.5 A), as shown in Figure 11.

As described, the battery is engaged less for the ECMS strategy, therefore, the fuel cell involvement and hydrogen consumption is higher (Fig. 12). Moreover, considering Figs. 7 and 10, the ultracapacitor engages only when the power demand is at max, therefore, reduces the stresses applied on the battery.

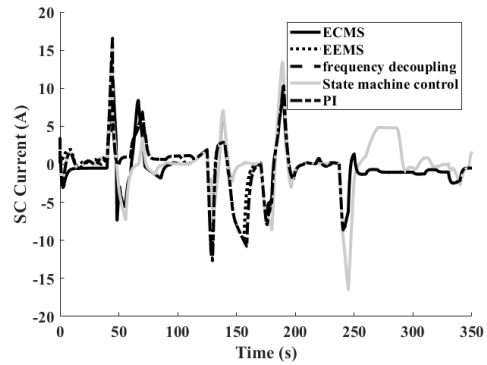

Fig.10. SC current on different schemes at a constant temperature (25 °C)

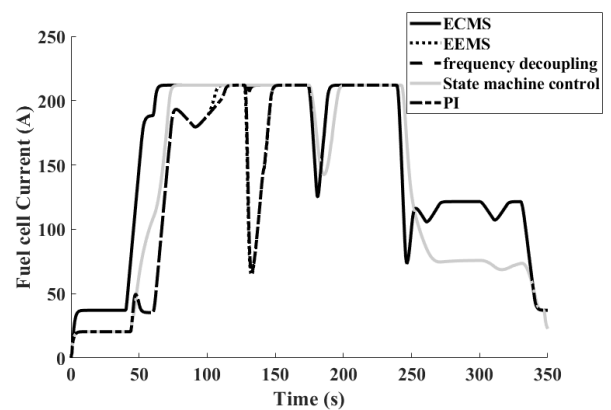

Fig.11. Fuel cell current on different schemes at a constant temperature (25 °C)

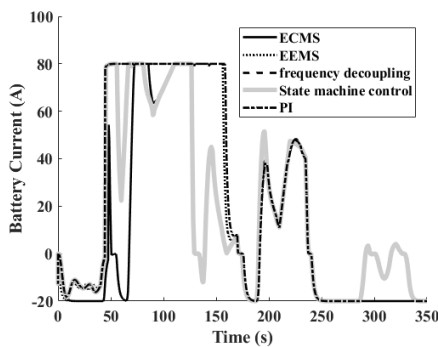

Fig.8. Battery current on different schemes at a constant temperature (25 °C)

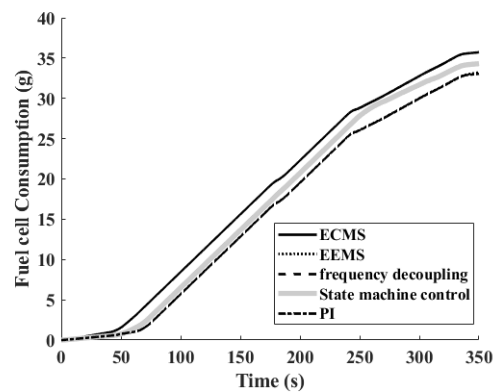

Fig.12. Fuel cell consumption on different schemes at a constant temperature (25 °C)

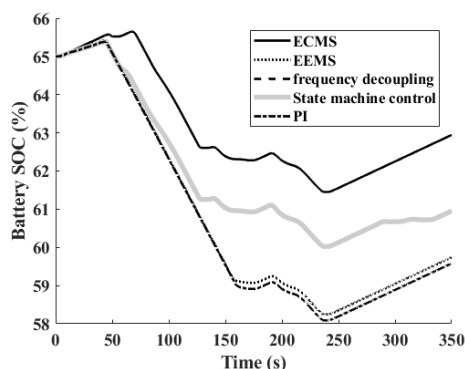

Fig.9. Battery SOC on different schemes at a constant temperature (25 °C)

4.2 Battery considering temperature variations

In this section, the energy management system model is the same, however, the battery temperature effects are considered using the model described in Section A.

Battery life investigation of a hybrid energy management system

Fig.13 shows that EEMS and PI have the maximum average current (25.72 A and 26.41 A, respectively), therefore the battery life is minimum (2.46 years for both). ECMS have the least average current (14.49 A) and the least time at peak level, therefore, it has maximum life (2.84 years). State machine control and frequency decoupling approximately have same battery current with average current 21.91 (A) therefore it has second rank in battery life. This data shows that battery power and life dependent on battery temperature like Masih and Zheng [23][12] but this difference between fixed and variant temperature do not change ranking between different strategy.

Fig 14 shows the battery SOC. The ECMS strategy provides the maximum SOC. This is due to the less engagement of the battery for this strategy, compared with other methods, as described in the constant temperature condition in section A. The PI, EEMS, frequency decoupling, and state machine control strategies are at the next levels, with the average current of 14.49, 21.91, 21.91, 25.72, 26.41 Ampere, respectively.

The increase of temperature results in the increase of battery power and reduction of its lifetime. As shown in Fig. 15, fuel cell has the highest average current for the ECMS (151.4 A), compared with other methods, similar to the arguments made for the constant temperature condition in section A. Therefore, the battery provides less power.

Fig. 13 shows that the ECMS strategy has the least average current (14.49 A), while the other ones has almost the double amount of current. Therefore, the battery SOC remains higher for this strategy as shown in Fig. 15.

Fig. 18 shows that due to lower engagement of the battery for the ECMS, the battery temperature remains lower, therefore, it provides longer battery lifetime. The ultracapacitor engages when necessary, similar to the constant temperature case and the average current for all control strategies is almost zero as shown in Fig. 16. The average current drawn from the ultracapacitor for the frequency decoupling, state machine control, and ECMS are 3.02, 3.14, and 3.14 Ampere, respectively. The PI and EEMS have the highest current by 3.39 and 3.37 A, respectively.

As mentioned in the constant temperature case in Section A, the fuel cell consumption for the

ECMS is higher; therefore, hydrogen consumption is larger for this strategy, as shown in Fig. 17. The total hydrogen consumption for the ECMS is 12.2% larger compared with the PI method (35.97 and 31.57 grams, respectively). This is while the battery life is increased by 13.43% (2.84 and 2.46). It is noticed that when the temperature effects are considered, the improvements are more significant.

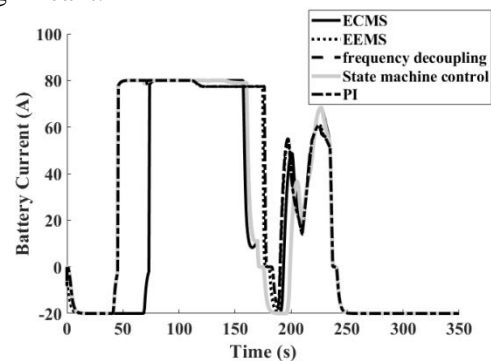

Fig.13. Battery current on different schemes with considering temperature variations (The ambient temperature=25 °C)

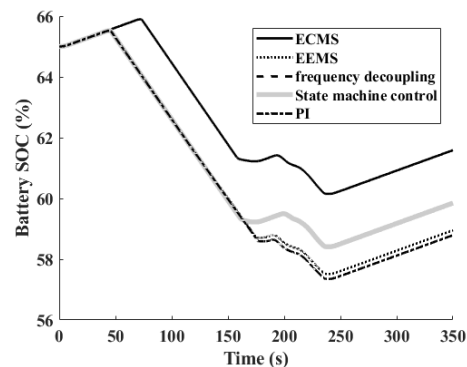

Fig.14. Battery SOC on different schemes with considering temperature variations (The ambient temperature=25 °C)

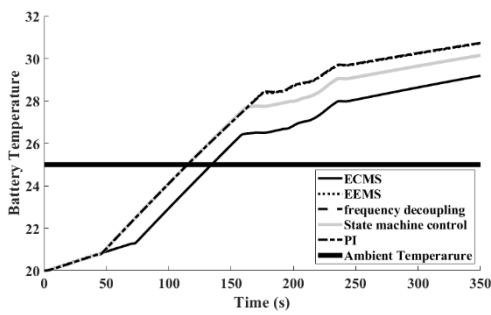

Fig.18. Battery temperature on different schemes with considering temperature

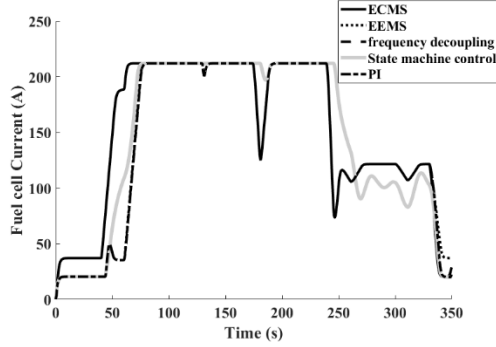

Fig.15. Fuel cell current on different schemes with considering temperature variations (The ambient temperature=25 °C)

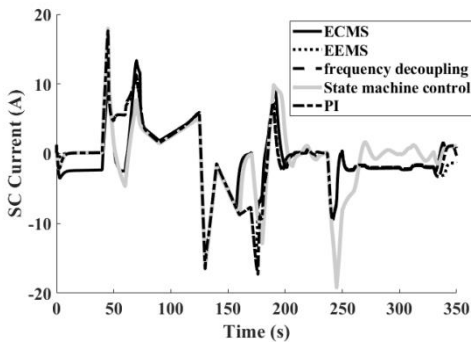

Fig.16. SC current on different schemes with considering temperature variations (The ambient temperature=25 °C)

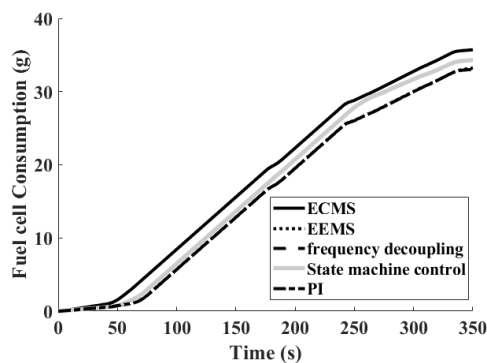

Fig.17. Fuel cell consumption on different schemes with considering temperature variations (The ambient temperature=25 °C)

4.3 Comparison of different energy management systems

Fig.17 is shown the comparison of different schemes battery life. From Fig.17 is obtained that ECMS has maximum battery life but difference of battery life is not too much. Fig.18 is battery life different schemes but temperature of battery is simulated in this chart. ECMS has maximum battery life but difference of battery life is more than constant temperature. Fig.19. is shown the effect of temperature in battery current. From Fig.19 can obtained because simulated temperature has higher current average than constant temperature, it has better battery than fixed temperature.

Figs. 20 and 21 show that the fuel cell and ultracapacitor has almost similar behavior for the constant temperature and varying temperature cases, in such a way that average difference in fuel cell and ultracapacitor currents are 1.1 and 0.18 A, respectively. It is also noticed that when the temperature is not modeled, the associated error with the battery current would be about 20%, and the one for the battery life is about 30%, which is a significant value.

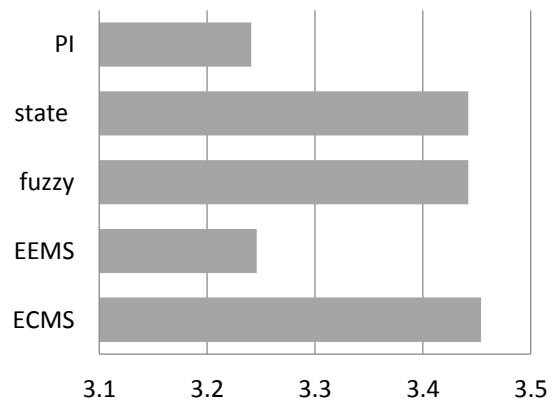

Fig.19. Battery life at fixed temperature (25 °C)

Battery life investigation of a hybrid energy management system

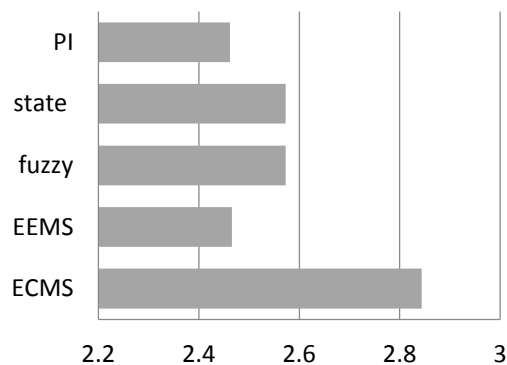

Fig.20. Battery life considering temperature variations (Ambient temperature=25 ° C)

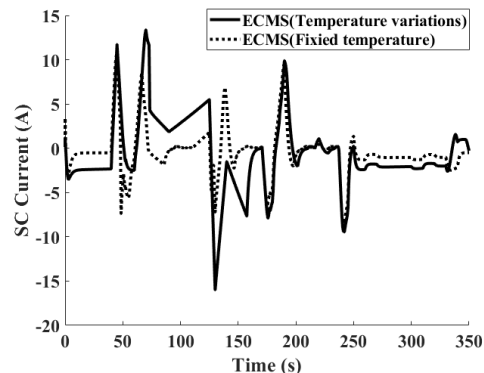

Fig.23. SC current (comparison of both situation)

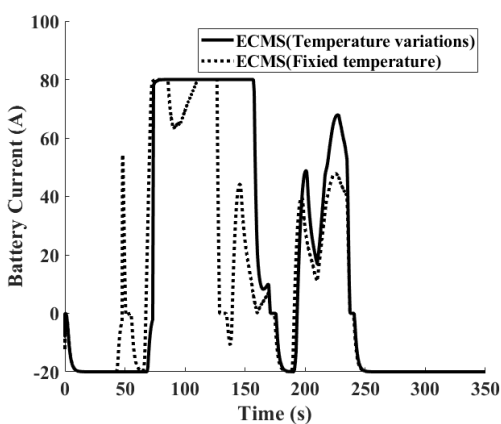

Fig.21. Battery current (comparison of both situation)

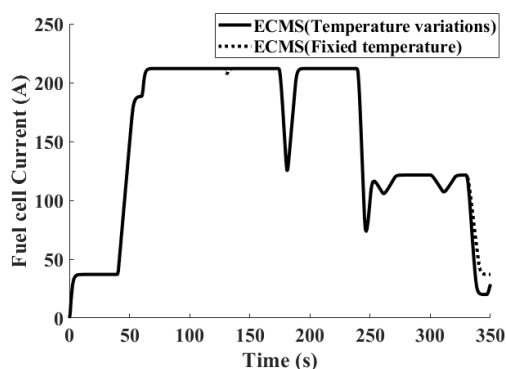

Fig.22. Fuel cell current (comparison of both situation)

As shown in Table 2, the ECMS scheme has the best battery life for both conditions. On the other hand, ECMS have minimum consumption of hydrogen.

Table 2: ECMS improve battery life than other strategies (%)

Strategy \ Condition	State machine control	PI	Frequency decoupling	EEMS
Battery constant temperature= T_{BC}				
$T_{BC} = 15^{\circ}\text{C}$	0.3	6.8	0.3	6.5
$T_{BC} = 25^{\circ}\text{C}$	0.3	0.6	0.3	0.6
$T_{BC} = 35^{\circ}\text{C}$	0.2	0.2	0.2	5.6
Simulated temperature with ambient temperature= T_{amb}				
$T_{amb} = 15^{\circ}\text{C}$	-2.4	0	-2.4	0
$T_{amb} = 25^{\circ}\text{C}$	10.5	15.5	10.5	15.3
$T_{amb} = 35^{\circ}\text{C}$	9.8	15.8	9.8	15.6

5. conclusion

This paper investigates the effect of temperature on a hybrid energy storage system with various energy management systems. The hybrid energy storage system consists of a fuel cell, battery and ultracapacitor. At first, the battery life is investigated under various energy management strategies without considering the temperature effects. Next, the

battery life is studied considering thermal effects for the battery model. It is noticed that different strategies employ battery, ultracapacitor and fuel cell differently at a driving cycle, therefore, the battery life is different. Hydrogen consumption is provided in order to have a fair comparison for the battery life mode, as well as the fuel cell behavior. It should be noted that in real world, the temperature variations are associated with the battery; therefore, it is inevitable to consider it. The results suggest that the errors associated with the battery life estimations, as well as the battery current are significant with and without considering the temperature effects.

6. References

- [1] M. H. Shojaeefard, G. R. Molaeimanesh, M. Nazemian, and M. R. Moqaddari, "A review on microstructure reconstruction of PEM fuel cells porous electrodes for pore scale simulation," *International Journal of Hydrogen Energy*. 2016.
- [2] B. Mashadi and S. A. M. Emadi, "Dual-mode power-split transmission for hybrid electric vehicles," *IEEE Trans. Veh. Technol.*, 2010.
- [3] J. Wang, P. Liu, J. Hicks-Garner, E. Sherman, S. Soukiazian, M. Verbrugge, H. Tataria, J. Musser, and P. Finamore, "Cycle-life model for graphite-LiFePO₄ cells," *J. Power Sources*, vol. 196, no. 8, pp. 3942–3948, 2011.
- [4] Y. H. - and H. L. -, "Characteristic Study of Lithium Iron Phosphate Batteries," *Int. J. Digit. Content Technol. its Appl.*, vol. 6, no. 5, pp. 264–272, 2012.
- [5] O. Tremblay and L. A. Dessaint, "Experimental validation of a battery dynamic model for EV applications," *World Electr. Veh. J.*, 2009.
- [6] M. Masih-Tehrani, M.-R. Ha'iri-Yazdi, V. Esfahanian, and A. Safaei, "Optimum sizing and optimum energy management of a hybrid energy storage system for lithium battery life improvement," *J. Power Sources*, vol. 244, pp. 2–10, 2013.
- [7] M. H.-Y. M. Masih-Tehrani, V. Esfahanian, "Energy Storage Hybridization for Lithium Battery Lifetime Improvement," *16th Int. Meet. Lithium Batter.*, vol. 17.
- [8] M. Masih-Tehrani and R. Yahyaei, "Study of Lithium Battery Thermal Effect on Battery and Hybrid Battery/Ultra-Capacitor Sizing for an Electric Vehicle," *researchgate.net*.
- [9] N. Bouchhima, M. Gossen, S. Schulte, and K. P. Birke, "Lifetime of self-reconfigurable batteries compared with conventional batteries," *J. Energy Storage*, 2018.
- [10] B. Xu, A. Oudalov, A. Ulbig, G. Andersson, and D. S. Kirschen, "Modeling of lithium-ion battery degradation for cell life assessment," *IEEE Trans. Smart Grid*, 2018.
- [11] S. Njoya Motapon, L. A. Dessaint, and K. Al-Haddad, "A comparative study of energy management schemes for a fuel-cell hybrid emergency power system of more-electric aircraft," *IEEE Trans. Ind. Electron.*, vol. 61, no. 3, pp. 1320–1334, 2014.
- [12] M. Masih-Tehrani and M. Dahmardeh, "A Novel Power Distribution System Using State of Available Power Estimation for a Hybrid Energy Storage System," *IEEE Trans. Ind. Electron.*, vol.

Battery life investigation of a hybrid energy management system

- 0046, no. c, pp. 6676–6685, 2017.
- [13] L. H. Saw, K. Somasundaram, Y. Ye, and A. A. O. Tay, “Electro-thermal analysis of Lithium Iron Phosphate battery for electric vehicles,” *J. Power Sources*, 2014.
- [14] C. Zhu, X. Li, L. Song, and L. Xiang, “Development of a theoretically based thermal model for lithium ion battery pack,” *J. Power Sources*, 2013.
- [15] P. Garcia, L. M. Fernandez, C. A. Garcia, and F. Jurado, “Energy management system of fuel-cell-battery hybrid tramway,” *IEEE Trans. Ind. Electron.*, 2010.
- [16] P. T. and S. Rael, P. Thounthong, and S. Rael, “The benefits of hybridization,” *Ind. Electron. Mag. IEEE*, vol. 3, no. The benefits of hybridization, pp. 25–37, 2009.
- [17] B. Vural, A. R. Boynuegri, I. Nakir, O. Erdinc, A. Balikci, M. Uzunoglu, H. Gorgun, and S. Dusmez, “Fuel cell and ultra-capacitor hybridization: A prototype test bench based analysis of different energy management strategies for vehicular applications,” *Int. J. Hydrogen Energy*, 2010.
- [18] P. Rodatz, G. Paganelli, ... A. S.-C. engineering, and undefined 2005, “Optimal power management of an experimental fuel cell/supercapacitor-powered hybrid vehicle,” *Elsevier*.
- [19] P. García, J. P. Torreglosa, L. M. Fernández, and F. Jurado, “Viability study of a FC-battery-SC tramway controlled by equivalent consumption minimization strategy,” *Int. J. Hydrogen Energy*, 2012.
- [20] S. N. Motapon, L. A. Dessaint, and K. Al-Haddad, “A robust H₂-consumption-minimization-based energy management strategy for a fuel cell hybrid emergency power system of more electric aircraft,” *IEEE Trans. Ind. Electron.*, 2014.
- [21] W. Jiang and B. Fahimi, “Active current sharing and source management in fuel cellbattery hybrid power system,” in *IEEE Transactions on Industrial Electronics*, 2010.
- [22] K. Jin, X. Ruan, M. Yang, and M. Xu, “A hybrid fuel cell power system,” *IEEE Trans. Ind. Electron.*, 2009.
- [23] F. Zheng, J. Jiang, B. Sun, W. Zhang, and M. Pecht, “Temperature dependent power capability estimation of lithium-ion batteries for hybrid electric vehicles,” *Energy*, 2016.