

Determination of the three-axle bus critical speed in the sense of rollover stability respect to the driver command and the road conditions

A. Otadi^a M.Masih-Tehrani^{**} S.M. Boluhari^a A.Darvish-Damavandi^a

^a School of Automotive Engineering, Iran University of Science and Technology, Tehran, Iran

* Corresponding Author, masih@iust.ac.ir

Abstract

In this paper, a three-axle bus rollover threshold and the effective parameters are studied. The rollover threshold is a speed that automotive is passing without occurring rollover. The objective is a determination of the heavy vehicle rollover critical speed while turning. For this purpose, a three-axle bus is studied. The dynamic equations related to rollover is extracted, and then rollover criterion, which is LTR (Load Transfer Ratio) in this paper, is obtained. The governing equations are simulated in MATLAB software and then the effect of the parameters such as steering rate, road curvature radius, road bank slope and automotive effective parameters on the rollover critical speed is studied. Prior to the investigation of these parameters, due to validation of the simulation model in MATLAB, a three-axle bus with specific parameters values is placed under various maneuvers with different conditions in TruckSim software then results are recorded. In order to validate, these results are compared with the results which are achieved from MATLAB. After validation, the relation between effective parameters in rollover stability and vehicle speed for desire maneuvers is obtained and it is illustrated in form of function. The results of this research work can be used in road threshold speed without huge computation costs and expensive tests.

Keywords: Rollover stability, Three-axle bus, Road condition, Load transfer ratio

1. Introduction

According to the US National Highway Traffic Safety Administration [1], damage from vehicle rollover accidents has been ranked second among all driving accidents. Because of the high load characteristics, high center of mass height and high aspect ratio, heavy duty vehicles tend to rollover in certain conditions such as fast steering, high velocity and very low turning radius. In the event of a heavy vehicle accident, there will be many of human and financial losses. Therefore, identifying and researching the stability of the car during the normal driving and the cornering maneuvers have become an important issue around the world.

In recent years, researchers have done many studies into the vehicle rollover, which involves evaluating various kinds of the vehicle rollover mechanisms and the immediate rollover warning algorithms. Rakhja and Piche [2] have proposed a

rollover warning algorithm, in which, when the wheels are separated from the ground, a relative rollover occurs and the lateral acceleration is considered to be critical. Chen and Peng [3] proposed a predetermined time for the rollover warning algorithm. The proposed algorithm has different rollover threshold for different models, which is due to the specific limitations of the proposed algorithm. Hyun and Langari [4] have used from lateral “load transfer ration” for detecting the vehicle rollover stability, which is simple and today is used as one of the most used indicators in car rollover performance. Guizhou Normal University [5], Nanjing Aeronautics and Space University [6], Jilin University [7], Chongqing Jiaotong University [8], Huaiyin Institute of Technology [9], and other research centers later followed some local researches on vehicle rollover.

In this paper, the load transfer ratio is considered as an indicator of heavy vehicle rollover. In the next section, the dynamic model of the vehicle is developed, and then the relationship between the

three-axle bus inputs in different driving conditions and the lateral load transfer ratio are investigated.

2- Equations governing the problem

A three-degree of freedom model of a three-axle bus with XYZ direction and forces is shown in Figure 1.

To simplifying the model, Assumptions are considered as follows:

- 1-The steering system is rigid.
- 2- The unsuspended mass roll is ignored due to negligence.
- 3- The speed is constant along the longitudinal axis.

The dynamical equations of the vehicle are presented in three directions in the form of Equation (1).

$$2aF_{CL1} \cos \delta_{o,i} - 2bF_{CL2} - 2(b+c)F_{CL3} = I_z \dot{\omega} \tag{1}$$

$$2(F_{CL1} \cos \delta_{o,i} + F_{CL2} + F_{CL3}) = m\dot{V} - mh\ddot{\Phi} \cos \alpha - mg \sin \alpha$$

$$m a_y h + mg \cos(\alpha + \Phi) h \Phi - (K_\Phi \Phi + C_\Phi \dot{\Phi}) h + F_w s_y \cos(\alpha + \Phi) + mg \sin(\alpha + \Phi) h = I_x \ddot{\Phi}$$

$$F_{cli} = -C_i a_{li} \quad (i = 1,2,3)$$

$$F_{cRi} = -C_i a_{Ri} \quad (i = 1,2,3)$$

$$a_{R1} = \delta - \tan^{-1} \left(\frac{v + \omega a}{u - 0.5\omega B} \right)$$

$$a_{R3} = -\tan^{-1} \left(\frac{v - \omega(b+c)}{u - 0.5\omega B} \right)$$

$$a_{l1} = \delta - \tan^{-1} \left(\frac{v + \omega a}{u + 0.5\omega B} \right)$$

$$a_{l2} = -\tan^{-1} \left(\frac{v - \omega a}{u + 0.5\omega B} \right)$$

$$a_{l3} = -\tan^{-1} \left(\frac{v - \omega(b+c)}{u + 0.5\omega B} \right)$$

$$a_y = \dot{V} + \omega u$$

$$\omega = \frac{\sqrt{u^2 + v^2} \cdot \delta}{a + b + 0.5c}$$

$$R = \frac{a + b + 0.5c}{\delta}$$

With respect to the relations, the parameter R is the radius of the curve, I_x, y, z , the moment of inertia of the vehicle in three directions, K_Φ the roller rotational stiffness, C_Φ the damping coefficient of the roll, Φ the angle of roll, Φ_B the latitude slope of the road, h_o the distance between Center of mass of the vehicle and the ground, h The distance between center of mass and the center of the roll, a The distance between center of mass and the front axle, b The distance between center of mass and the middle axis, c The distance between the middle axis and the rear axis and δ Steering wheels angle

The forces and moments in the vehicle are shown in Figures 2 and 3

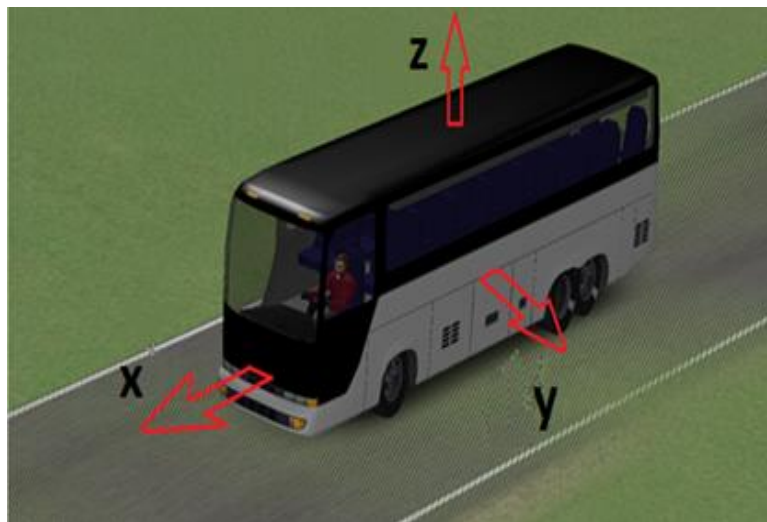

Figure 1: Vehicle coordinate system axes

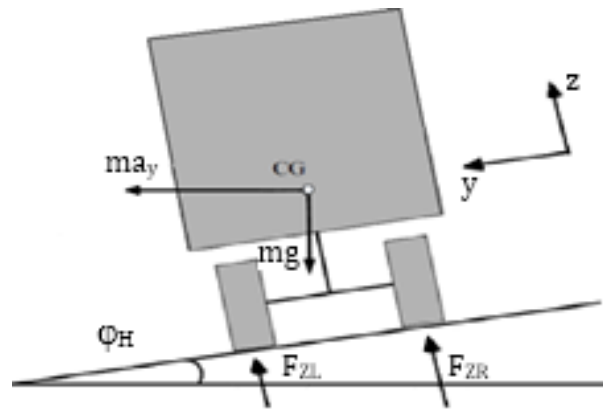

Figure 2: Vertical forces acting on the car

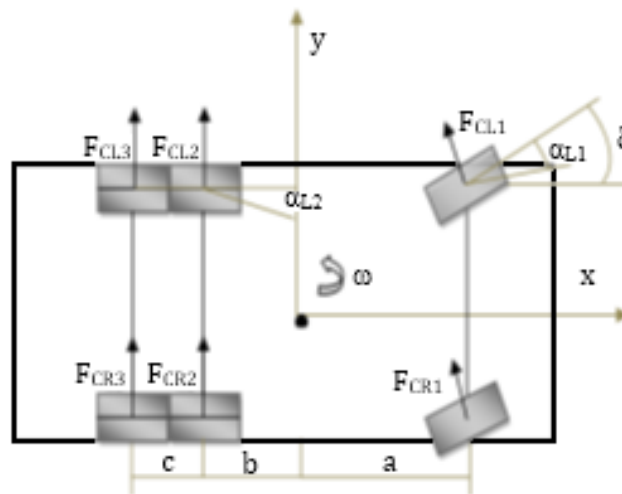

Figure 3: Lateral forces and torques exerted on the vehicle

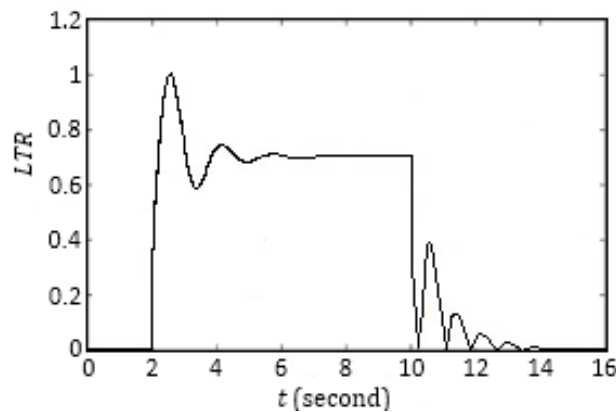

Figure 4: LTR diagram versus time

2-1- ratio of lateral load transfer

When the vehicle is in curve, slope, or exposing the wind, a load transfer occurs in the tires, so that the

vertical forces of the tires are not equal in the left and right sides. By calculating the torque equation, we can calculate the amount of this load transfer from equation (2).

$$LTR = \left| \frac{F_{z1} - F_{zr}}{F_{z1} + F_{zr}} \right| \quad (2)$$

Also, by inserting the parameters, the relation (2) is converted to (3).

$$LTR = \left| \frac{2}{T} \left(\frac{I_x \ddot{\phi} - m h_0 a_y - m g \sin \Phi h + m g \sin(\beta + \Phi) h}{m g} \right) \right| \quad (3)$$

When F_{z1} or F_{zr} is zero, LTR become 1, this state is critical and the overturning starts and when $F_{z1} = F_{zr}$, LTR will become 0. As a result, the variation in the load transfer coefficient is [0,1], which value of 1 is for the overturning and less is the steady state of the vehicle. The load transfer coefficient diagram versus time when the vehicle enters the curve and then become stable is shown in Figure 4.

In Figure 4, the vehicle has entered the curve in point 2 and the value of the longitude load transfer

ratio, which is a benchmark of the stability of the vehicle, has risen to the threshold of overturning in the amount of 1. Then vehicle continues at a steady state situation in a curve until it exits at a point 10

3- Simulating model

The simulated vehicle model in MATLAB is shown in Figure 5. The input parameters of the dynamic model are $u, \delta, m_s, m_t, h, h_0$ and the output parameter is the load transfer ratio. The input parameters and vehicle parameters are given in Table 1.

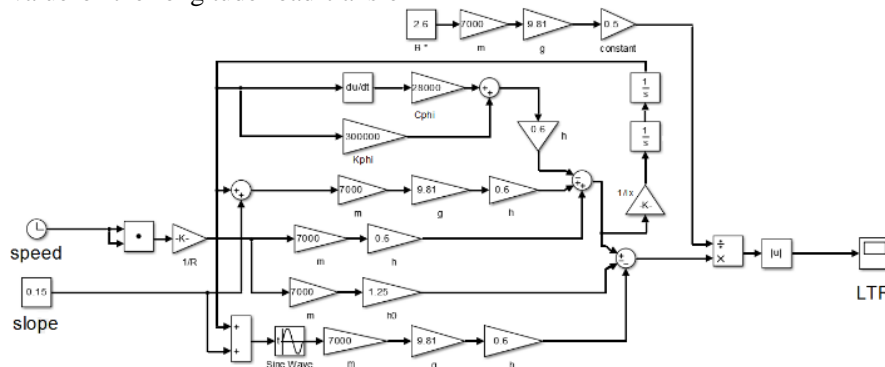

Figure 5: Vehicle dynamic model in MATLAB

Table 1: Vehicle parameters values

parameter	amount	symbol
Whole mass	8715 kg	m_t
Suspended mass	7000 kg	m_s
Distance between front axle and rear axle	6.98 m	L
Distance between front axle and center of mass	3.5 m	a
Distance between middle axle and center of mass	2.29 m	b
Distance between middle axle and rear axle	1.18 m	c
Moment of inertia in direction of x	2310.5 kg/m ²	I_x
Moment of inertia in direction of y	35437.5 kg/m ²	I_y
Moment of inertia in direction of z	34693.7kg/m ²	I_z
Vehicle width	2 m	T
Torsion stiffness	209000 nm/rad	K_ϕ
Torsion damping	30000 nm/rad	C_ϕ
Center of mass height	1.5 m	h_0
Center of roll height	0.575 m	h



Figure 6: Triaxial bus while cornering and rollover in TruckSim software

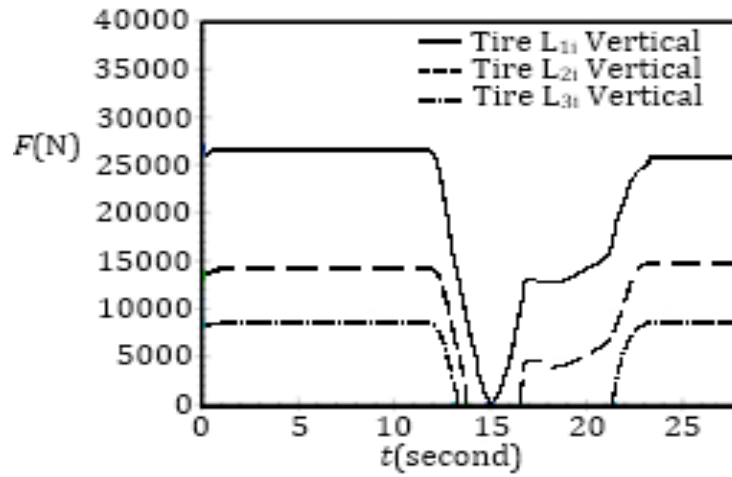

Figure 7: In turn tires vertical forces while rollover

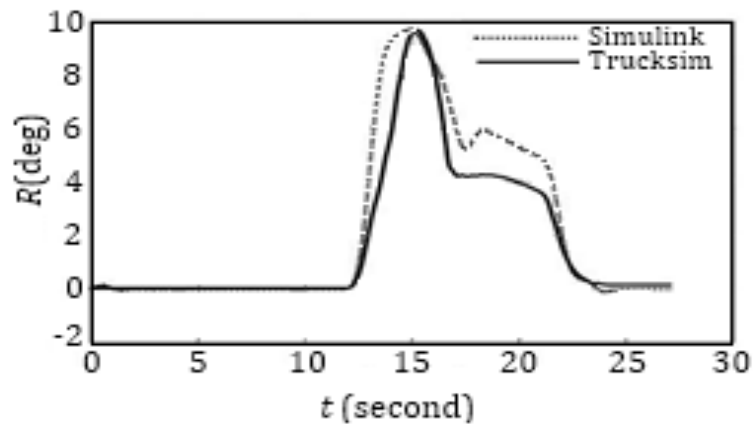

Figure 8: Comparing diagram of the vehicle body roll angle in 40 m cornering radius

4- Verifying the simulated model

In order to validate the simulated MATLAB model, TruckSim software is used. An illustration of the ideal vehicle when you are turning around in the TruckSim software is shown in Figure 6

Also, the overturning benchmark in this study, which is the vertical forces in all inward tires are zero, is shown in Figure 7

In order to verify the vehicle parameters are presented in the TruckSim and the diagram of the body roll's angle in a 40-meter maneuver without transverse slope is compared in two software in Figure 8. Comparison of the two diagrams shows good compatibility at a critical moment.

5- Review of various maneuvers

After validating the model in MATLAB software, various maneuvers are examined in this software and the relationship between the vehicle rollover critical speed with the radius of the road without transverse slope is investigated and it is shown in Figure 9. This

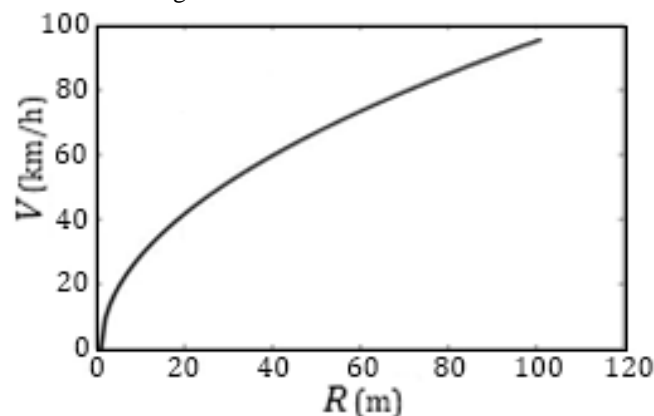

Figure 9: Vehicle rollover critical speed diagram versus cornering radius in the steady-state case

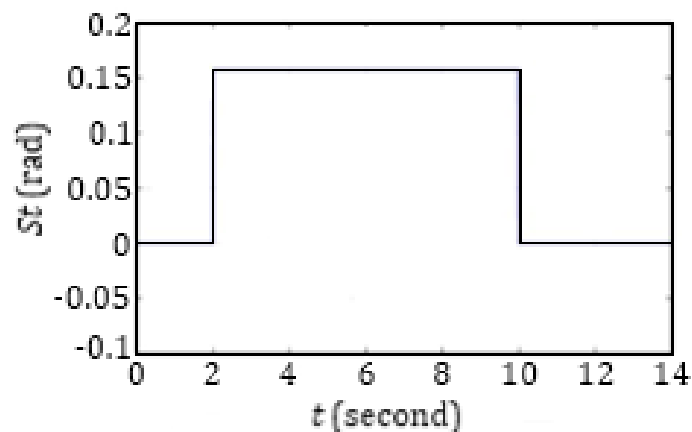

Figure 10: Steering wheels angle diagram in step steering maneuver

diagram is obtained by inserting different radii and the velocities in which the radii are in a steady state, $LTR = 1$, and the vehicle is at the overturning threshold. As it is known, with the increase in the radius of the road, the vehicle rollover critical speed would be increased.

5-1- Step steering maneuver

In a step steering maneuver, the steering wheel angle is immediately changed when the vehicle is entered into a 40-meter radius and then immediately exit. In Figure 10, the angles of the wheels are shown for this maneuver.

In this maneuver, the speed of a vehicle is $U = 43.5$ Km/h. The vehicle rollover critical speed versus the transverse load transfer coefficient's graph for this maneuver is shown in Figure 11.

In addition, the speed function toward radius for this maneuver is shown in Figure 12

The vehicle speed function is toward radius for this maneuver is $U = 5.9 \sqrt{R} + 39.38$

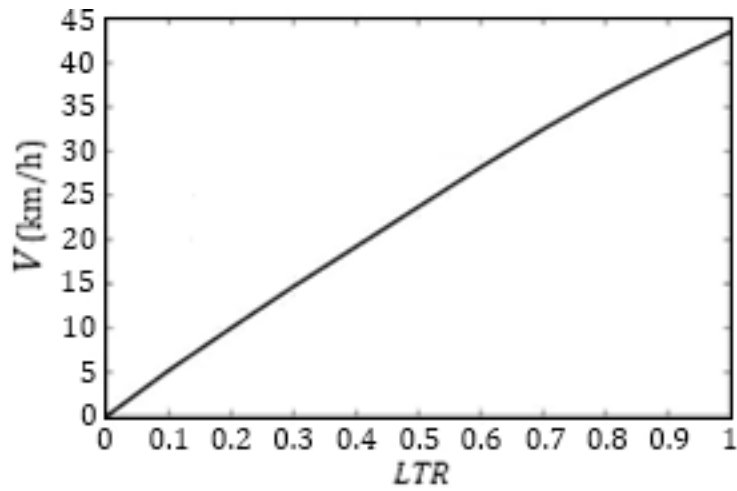

Figure 11: Vehicle speed diagram versus LTR in step steering maneuver

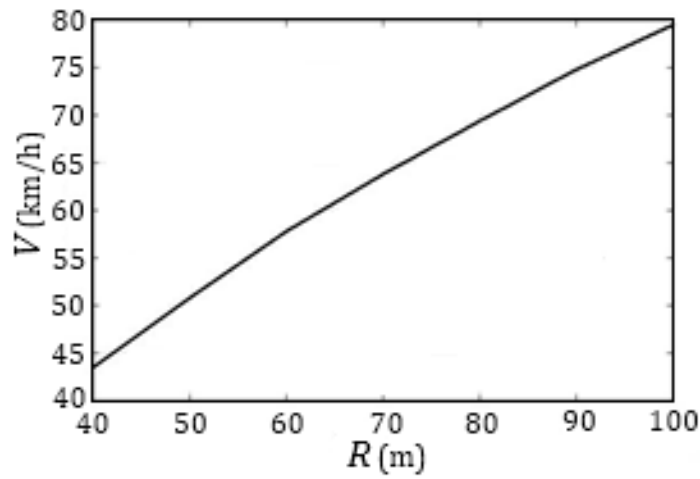

Figure 12: Vehicle speed diagram versus the cornering radius in step steering maneuver

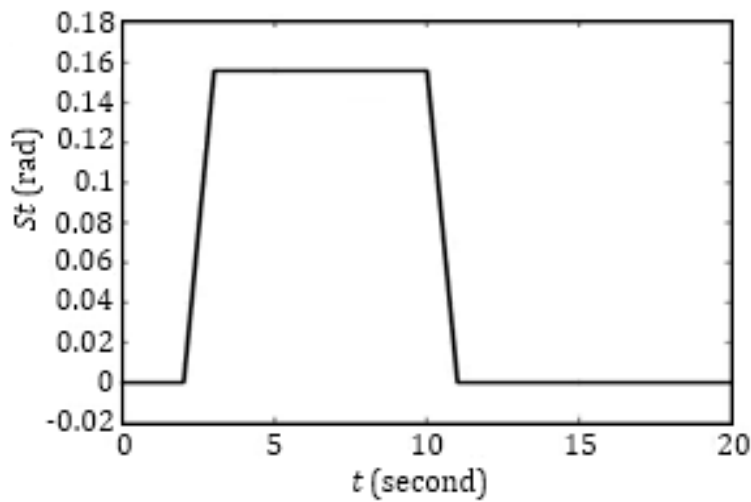

Figure 13: Steering wheels angle diagram in ramp steering maneuver

5-2- 0.5 Sec Ramp steering maneuvers

In ramp steering maneuvers, the steering is completed in 0.5 seconds, so that the vehicle enters into a 40-meter radius and then exits at a rate of 0.5 seconds. In Figure 13, the angles of the wheels are shown for this maneuver.

In this maneuver, the speed of a vehicle is $U = 48.3$ Km/h. The rollover critical speed function toward radius for this maneuver is shown in Figure 14.

The vehicle speed function is toward radius for this maneuver is $U = 5.63\sqrt{R} + 44.1$

5-3- 1 Sec Ramp steering maneuvers

In this maneuver, the steering angle is completed in 1 second, and the vehicle enters into a 40-meter

radius and then exits at a rate of 1 second after a while. The rollover critical speed of the vehicle in this maneuver is $U = 54$ Km / h. The speed function toward radius for this maneuver is shown in Figure 15.

The vehicle speed function is toward radius for this maneuver is $U = 5.6\sqrt{R} + 49.68$.

5-4- Step transverse slope maneuver

In the Step transverse slope maneuver, the vehicle instantaneously enters a curve with a radius of 40-meters with a transverse slope of 10 percent. The rollover critical speed versus changes in transverse slope diagram is shown in Figure 16. In Figure 16, the negative slopes represent the outside transverse slope of the curve. Also, the speed versus radius for this maneuver is shown in Figure 17.

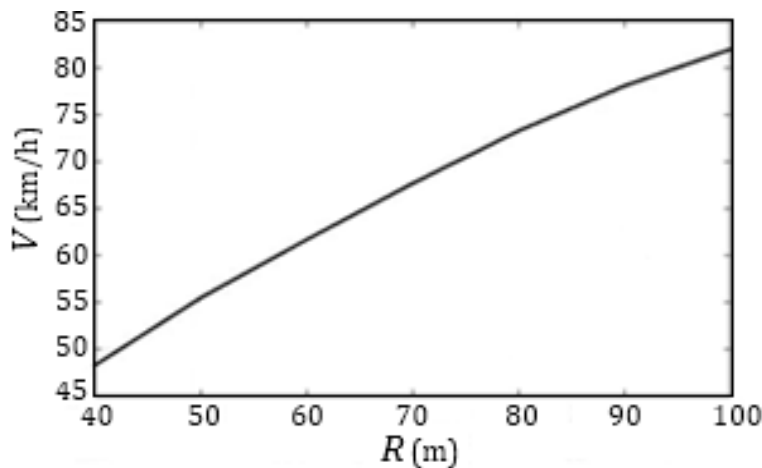

Figure 14: Vehicle speed diagram versus the cornering radius in 0.5 second ramp steering maneuver

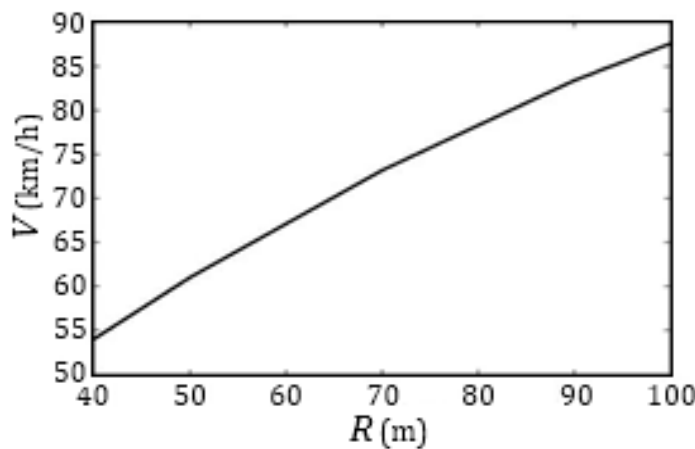

Figure 15: Vehicle speed diagram versus the cornering radius in 1 second ramp steering maneuver

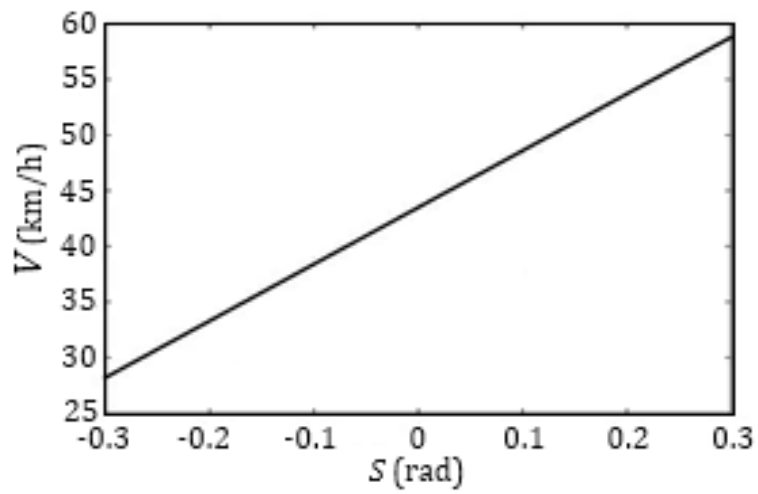

Figure 16: Vehicle speed diagram versus road bank

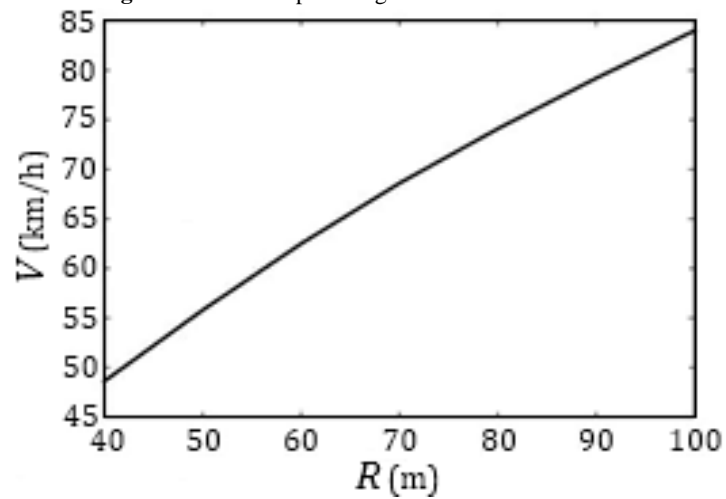

Figure 17: Vehicle speed diagram versus the cornering radius in step road bank maneuver

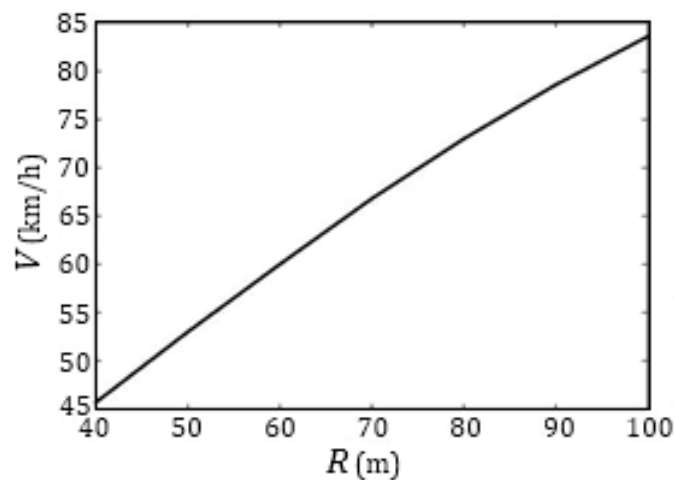

Figure 18: Vehicle speed diagram versus the cornering radius in 10 m ramp road bank maneuver

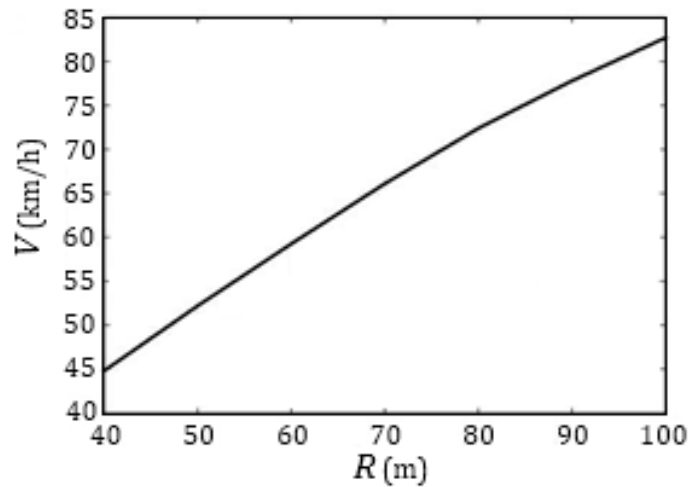

Figure 19: Vehicle speed diagram versus the cornering radius in 20 m ramp road bank maneuver

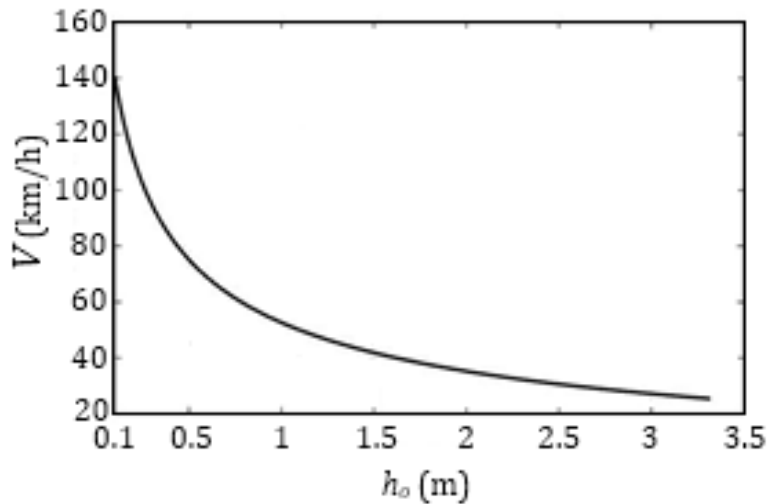

Figure 20: Vehicle rollover critical speed diagram versus the mass center of gravity height

5-5- 10-meter ramp transverse slope maneuver

In ramp transverse slope maneuver, after entering the vehicle into a 40-meter radius, the transverse slope reaches 10% after 10 meters. The speed versus radius for this maneuver is shown in Figure 18

5-6- 20-meter ramp transverse slope maneuver

In ramp transverse slope maneuver, after entering the vehicle into a 40-meter radius, the

transverse slope reaches 10% after 20 meters. The speed versus radius for this maneuver is shown in Figure 19

6- Studying effect of various vehicle parameters

In this section, the effect of vehicle parameters on the rollover critical speed of the vehicle is examined. The parameters of the vehicle are the physical parameters of the vehicle, such as the height of the center of mass, the torsional stiffness, the width of the vehicle, and the height of the center of the roll.

6-1- center of mass height

As shown in Figure 20, with the increase in the height of the center of the mass, the instability increases and the probability of the overturning is increased.

6-2- width

As shown in Figure 21, with increased vehicle width, stability increases and the overturning probability is reduced

6-3- height of roll center

As shown in Figure 22, with the increase in height roll center, the stability is reduced and the possibility of overturning is increased

6-4- torsional stiffness

As shown in Figure 23, with increasing torsional rigidity, the stability of the vehicle increases and the possibility of overturning is reduce.

6-5- suspended mass

As shown in Figure 24, with increasing vehicle suspended mass, the stability is reduced and the possibility of overturning is increased.

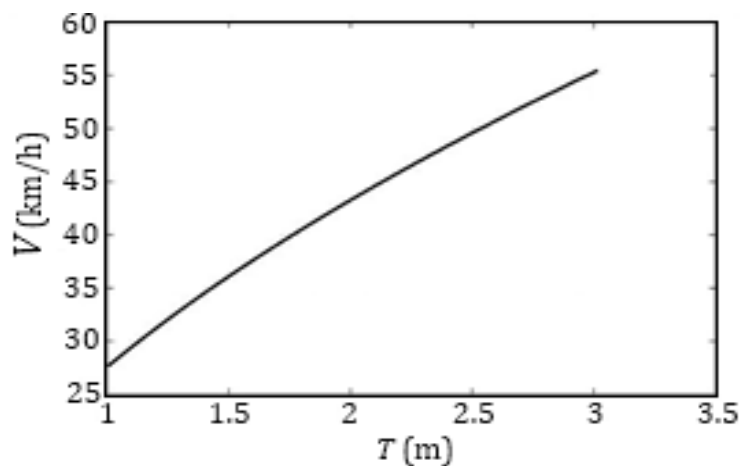

Figure 21: Vehicle rollover critical speed diagram versus the track

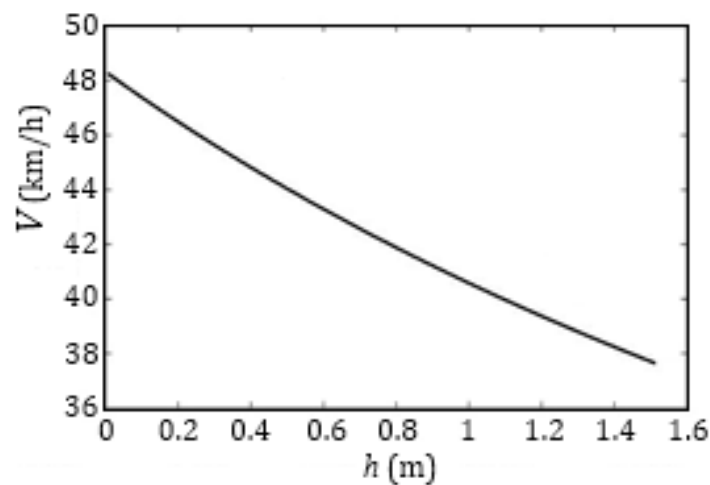

Figure 22: Vehicle rollover critical speed diagram versus the rolling center height

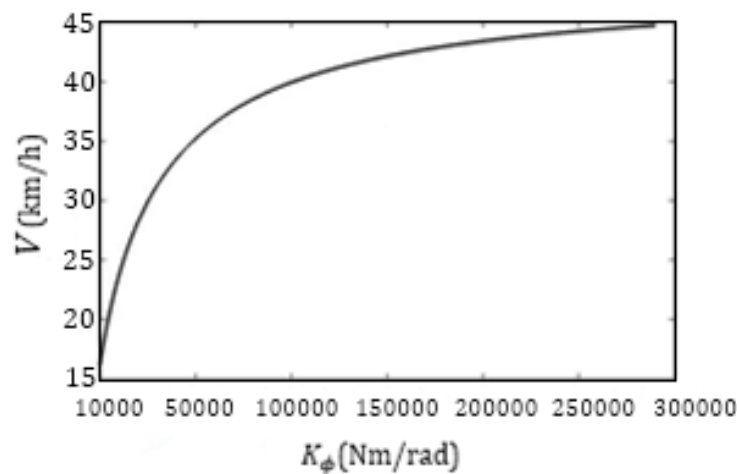

Figure 23: Vehicle rollover critical speed diagram versus the torsional stiffness

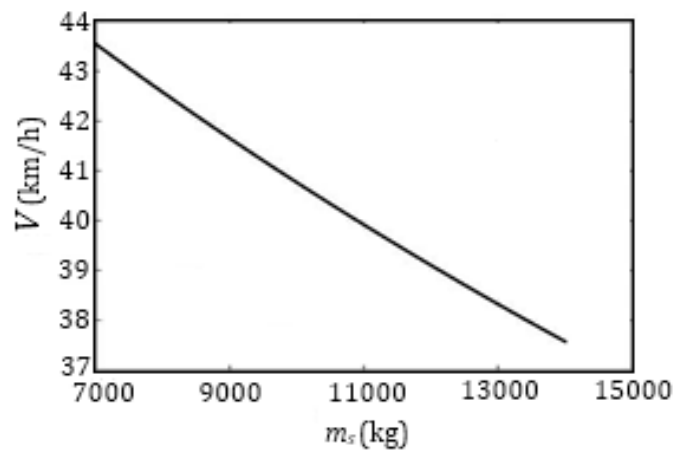

Figure 24: Vehicle rollover critical speed diagram versus the sprung mass

7- Conclusion

In this paper, a three-axle passenger bus was considered. To determine the vehicle's overturning stability, transient governing dynamical equations of bus motion have been developed. The dynamic model of the bus motion is considered as a three-degree freedom model, which includes rotation, rolling, and slip motion. This model was simulated in the Simulink of the MATLAB software with various bus parameters and various maneuvers such as steering input, transverse slope and road radius were simulated. Also, to create real conditions to check the stability of the vehicle, TruckSim software is used to validate the model created in the software. The comparison of the results of these two software, such as the angle of roll, shows good alignment when the vehicle enters the curve. The small difference that

occurs after the critical point of vehicle entry to the curve is due to several factors, such as variation of the Cornering Tire ($C\alpha$) coefficient toward time, the number of degrees of freedom, and the over-steer parameter in the TruckSim software. After confirming the model of the MATLAB by the TruckSim model, different maneuvers were modeled in MATLAB and the critical speed of the vehicle was at the overturning threshold for these maneuvers. Also, the effect of speed on the stability factor (transverse load transfer coefficient) is shown in the graphic diagram and the relationship between the rollover critical speed of the vehicle with the radius of the road for different maneuvers is obtained. According to the diagrams, the following results were obtained:

1- As the vehicle's longitudinal rollover critical speed increases, the transverse load factor increases as a second-order function, and at higher speeds, a

slight increase in the vehicle rollover critical speed increases the instability of the vehicle.

2- The vehicle rollover critical speed is increased by increasing the radius of the road in the form of a second-order function with a negative contraction and in higher radius, the effect of increasing the radius of the road on the increase in the speed is less

3- The rollover critical speed of the vehicle during various maneuvers has increased by a factor of 1.9 at a radius of 100-meters to the 40-meter radius

4- According to Figure 25, the step steering maneuver without transverse slope, is the most critical maneuver and stable maneuver with positive transverse slope, is the least dangerous maneuver in vehicle instability. The rollover critical speed of the vehicle in a steady state maneuver with a transverse slope is up to 1.45 times higher than step steering maneuver without transverse slope

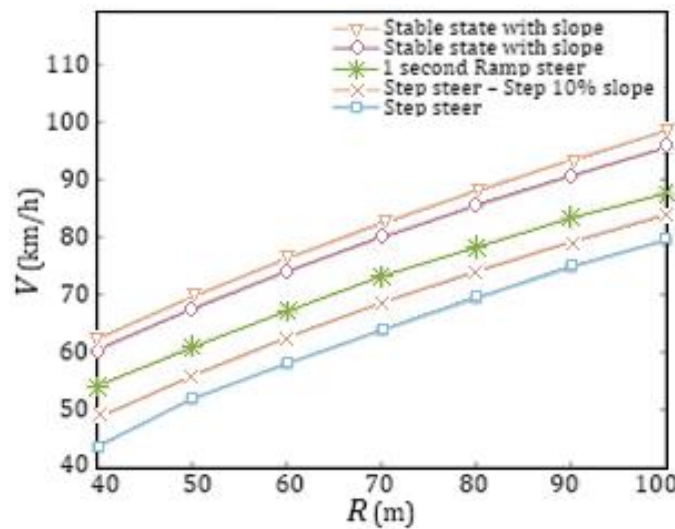

Figure 25: The maximum and minimum rollover critical speed limits for different maneuvers versus cornering radius

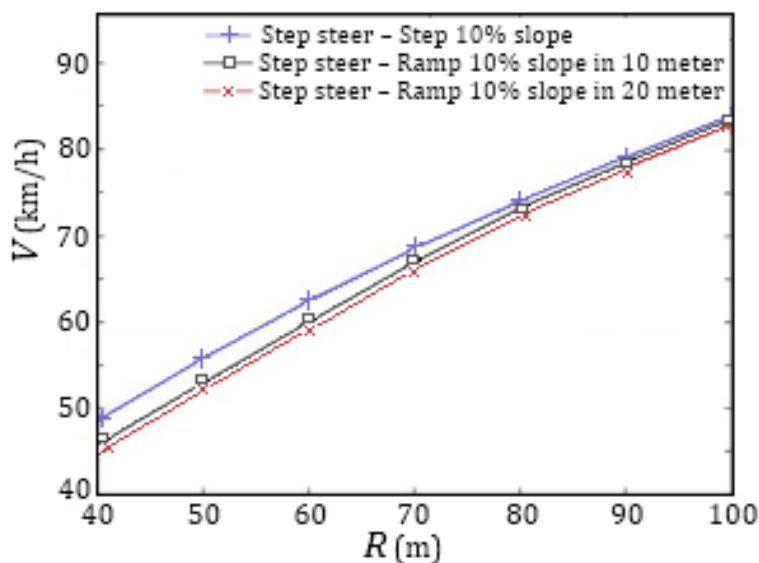

Figure 26: The maximum and minimum rollover critical speed limits for step steering maneuvers versus cornering radius

8- List of symbols

Distance between front axle and center of mass(m)	a
Distance between middle axle and center of mass(m)	b
Distance between middle axle and rear axle(m)	c
Torsion damping (Nms)	C_{ϕ}
Center of roll height (m)	h
Center of mass height (m)	h_0
Moment of inertia in direction of x (kgm ²)	I_x
Moment of inertia in direction of y (kgm ²)	I_y
Moment of inertia in direction of z (kgm ²)	I_z
Torsion stiffness (Nm)	K_{ϕ}
Distance between front axle and rear axle (m)	L
Suspended mass (kg)	m_s
Whole mass (kg)	m_t
Vehicle width (m)	T

Reference

- [1]. Z. Zhiguo, W. Dongdong, Research status and development trend of side tumbling pre-warning vehicle. Journal of Hebei University of Science and Technology, Vol. 34, Issue 2, pp. 108-112, 172, 2013.
- [2]. S. Rakheja and A. Piche, Development of directional stability criteria for an early warning safety device. SAE Paper No. 902265, 1990.
- [3]. B. Chen, H. Peng, Differential-braking-based rollover prevention for sport utility vehicles with human-in-the-loop evaluations. Vehicle System Dynamics, Vol. 36, Issue 4, pp. 359-389, 2001.
- [4]. D. Hyun, R. Langari, Modelling to predict rollover threat of tractor-semitrailers. Vehicle System Dynamics, Vol. 39, Issue 6, pp. 401-414, 2003.
- [5]. H. Feng, Y. Liyong, Estimation and analysis of the quasi-static rollover threshold for partially filled tank vehicles. Journal of Guizhou Normal University (Natural Science), Vol. 22, Issue 2, pp. 73-76, 2004.
- [6]. J. Zhilin, Z. Hongsheng, Ma Cuizhen. Research on dynamic rollover warning system for SUV. Transducer and Microsystem Technologies, Vol. 31, Issue 9, pp. 32-35, 38, 2012.
- [7]. Z. Changfu, Z. Tianjun, et al, Active roll control algorithm of heavy tractor Semi-trailer based on global gain scheduling control. Chinese Journal of Mechanical Engineering, Vol. 44, Issue 10, pp. 138-144, 2008.
- [8]. L. Jinjiang, Hardware design and software development on the antirollover control and the early warning system of the concrete mixer model truck, Chong Qing Jiaotong University, 2010.
- [9]. X. Jingjing, C. Lü, et al, Active control on the side tumbling of heavy vehicle based on model forecast. Transactions of the Chinese Society of Agricultural Engineering, Vol. 26, Issue 9, pp. 176-180, 2010.