

The Effects of Ethanol-Gasoline Blends on Performance and Exhaust Emission Characteristics of Spark Ignition Engines

A. Elfasakhany¹

¹Associate Professor, Department of Mechanical Engineering, Faculty of Engineering, Taif University, Saudi Arabia

ashr12000@yahoo.com

Abstract

The effects of unleaded gasoline and unleaded gasoline–ethanol blends on engine performance and pollutant emissions were investigated experimentally in a single cylinder, four-stroke spark-ignition engine with variable engine speeds (2600–3500 rpm). Four different blends on a volume basis were applied. These are E0 (0% ethanol + 100% unleaded gasoline), E3 (3% ethanol + 97% unleaded gasoline), E7 (7% ethanol + 93% unleaded gasoline) and E10 (10% ethanol + 90% unleaded gasoline). Results of the engine test indicated that using ethanol–gasoline blended fuels improve output torque, power, volumetric efficiency and fuel consumption of the engine; it was also noted that fuel consumption depends on the engine speed rather than the ethanol content for ethanol less than 10% blended ratio. CO and unburned hydrocarbons emissions decrease dramatically as a result of the leaning effect caused by the ethanol addition; CO₂ emission increases because of the improved combustion.

Keywords: Ethanol; Gasoline; Blends; Engine performance; Pollutant emission

1. Introduction

Indeed, the use of ethanol as a vehicle fuel dates back to the initial development of the automobile a century ago when Henry Ford designed his first automobile [1-2]. Currently, ethanol-gasoline blended fuel is the issue for spark ignition engines. In the literature review, the effects of ethanol–gasoline blended fuels on engine performance and/or exhaust emissions have been investigated by many researchers. Wu et al. [3] explained that the ethanol content plays an important role to improve the combustion process. Palmer [4] showed that addition of ethanol to unleaded gasoline resulted in an increase in octane number by 5 units for each 10% ethanol addition. He also stated that 10% ethanol in gasoline as a fuel additive improved the engine power by 5%. Kelly et al. [5] tested three fuels namely, base gasoline, E50 and E85 and found that running with E85 would decrease unburned hydrocarbon (UHC) and CO emissions in comparison with base gasoline. Cowart et al. [6] investigated the effect of E85 blended fuels on engine performance. They showed that when blended fuels were used, the engine torque and power increased with the E85 by 4%. Bata et al. [7] studied different blend rates of ethanol–gasoline fuels on engine emissions and they found that the ethanol reduced the CO and UHC emissions to some

degree. They referred the reduction of CO emission to the wide flammability and oxygenated characteristic of ethanol. Hasan [8] investigated the effect of ethanol–unleaded gasoline fuel blends on the performance of SI engine. The results showed that when ethanol blended gasoline fuel was used, brake power, brake thermal efficiency and volumetric efficiency increased by 8.3%, 9% and 7%, respectively, while the brake specific fuel consumption and air–fuel equivalence ratio decreased by 2.4% and 3.7%, respectively, as mean average values. The CO and UHC emission concentrations decreased, while the CO₂ concentration increased. He also concluded that 20% ethanol fuel blend (E20) gave the best results in the engine performance. Alexandrian and Schwalm [9] showed that using ethanol–gasoline blended fuel instead of gasoline alone, especially under fuel-rich conditions, can lower CO emission. Wu et al. [3] investigated the effect of using ethanol-gasoline blends. The result showed that output torque improved when using ethanol-gasoline blends. CO and UHC emissions reduced with the increase of ethanol content in the blended fuel. The study also found out that by using 10% ethanol fuel, pollutant emissions are reduced efficiently. Yucesu et al. [10] and Topgul et al. [11] investigated the effects of ethanol-gasoline blends (E0, E10, E20, E30, E40, and E60) on gasoline engine performance and exhaust emission in a single cylinder, four-stroke, spark-

ignition engine with variable compression ratio. They found that blending unleaded gasoline with ethanol slightly increased the brake torque and decreased CO and UHC emissions. It was also found that blending with ethanol allows increasing the compression ratio without knock occurrence. Celik [12] and Agarwal [13] explained that with increasing the ethanol content in gasoline fuel, the heating value of the blended fuels is decreased, while the octane number of the blended fuels increases. They showed that engine power increased by about 29% using E50 fuel at high compression ratio compared to running with E0 fuel. They also showed that the specific fuel consumption was reduced by approximately 3%. Rice et al. [14] stated that using higher percentage of ethanol in blended fuel can make the air quality better in comparison with gasoline. Hsieh et al. [15] used various blend rates of ethanol–gasoline fuels in engine tests (0%, 5%, 10%, 20% and 30% by volume). Results indicated that with increasing the ethanol content, the Reid vapor pressure of the blended fuels initially increases to a maximum at 10% ethanol addition, and then decreases. In addition, with increasing the ethanol content, the heating value of the blended fuels is decreased, while the octane number of the blended fuels increases. They also showed that using ethanol–gasoline blended fuels, torque and fuel consumption of the engine slightly increase. The CO and UHC emissions decrease dramatically as a result of the leaning effect caused by the ethanol addition, while CO₂ emission increases because of the improved combustion. Palmer [4] experimentally studied the engine performance and exhaust emission of SI engine using ethanol–gasoline blended fuels with various blended rates. Results indicated that 10% ethanol addition increases the engine power output by 5%, and the octane number can be increased by 5% for each 10% ethanol added. He also indicated that 10% of ethanol addition to gasoline could reduce the concentration of CO emission up to 30%. Bayraktar [16] reported that blending unleaded gasoline with ethanol increases the brake power, torque, volumetric and brake thermal efficiencies and fuel consumption, while it decreases the brake specific fuel consumption. The 20 vol.% ethanol in fuel blend gave the best results for all measured parameters at all engine speeds. Yucsu et al. [10] stated that using E40 and E60 blends led to a significant reduction of CO and UHC emissions. He et al. [17] reported that ethanol is to be an important contributor to decreased engine-out regulated emissions. Abdel-Rahman and Osman [18] had tested E10, E20, E30 and E40 in a variable-compression-ratio engine and they found that the increase of ethanol content increases the octane number, but

decreases the heating value. They also found that E10 is the optimum blend rate.

From the literature reviews showed above, researchers showed that ethanol–gasoline blended fuels can effectively lower the pollutant emissions and improves engine performance. However, other researchers showed that ethanol–gasoline blended fuels may increase the pollutant emissions. Moreover, the engine performance is not improved as blended fuels increased. He et al. [17], Cataluna et al. [19], Topgül et al. [20] and Guerrieri et al. [21] noted a rise in the indicated specific fuel consumption (ISFC) with the introduction of ethanol addition to gasoline. Pourkhesalian et al. [22] concluded that the engine operating on ethanol occurrences an average reduction in volumetric efficiency by 8% comparing to gasoline. De Melo et al. [23] stated that engine using ethanol blended fuels is a decrement in brake torque and power compared to gasoline. Ozsezen and Canakci [1] showed no change in engine power and the combustion efficiency decreased when the blends increased. Najafi et al. [24] showed no change in brake power, torque and brake specific fuel consumption (BSFC) when using ethanol/gasoline blends. Eyidogan et al. [25] showed the engine power decreases and no changes in both brake thermal efficiency and BSFC. Cahyono and Abu Bakar [26] showed that power decreased, CO increased and CO₂ decreased. MacDonald [27] showed a slightly increasing in CO emissions occurred when using ethanol/gasoline blends. Ozsezen and Canakci [1] showed that CO and UHC increased, while CO₂ decreased when ethanol blends increased in the fuel blends at particular engine speeds. Cataluna et al. [19] and Topgül et al. [20] noted that in the case of ethanol addition there is no real impact on CO₂ emissions, whereas Guerrieri et al. [21] and Jeuland et al. [28] observed a decrease. Park et al. [29] stated that using ethanol–gasoline blended fuel instead of gasoline alone can lower CO₂ emission. Celik [12] and Agarwal [13] also showed CO₂ emission was reduced by about 10% when using blended fuels. Song et al. [30] investigated the effect of the additives of ethanol to gasoline. The results showed that ethanol brought about generally higher regulated engine-out emission of UHC when using E90 and E100 fuels.

Based on the early literatures, the use of ethanol–gasoline blended fuels is not very clear improved/unimproved engine performance and pollutant emissions compared to the neat gasoline fuel. In this study, the effects of gasoline–ethanol blends on engine performance and pollutant emissions is investigated experimentally and

compared to the neat gasoline fuel at variable engine speeds. Four different blends on a volume basis were applied (E0, E3, E7 and E10).

2. Experimental apparatus and methods

The experimental apparatus includes three major systems, i.e., the engine system, performance measurement system and exhaust emissions measurement system. The engine system, as shown in Fig. 1, is a single cylinder with bore and stroke being 65.1 and 44.4 mm, respectively, and it is four strokes

with carburetor type SI engine. Detailed engine specifications are presented in Table 1.

Performance measurement system includes measurements of different parameters as fuel consumption, engine torque, power, volumetric efficiency, cylinder pressure, and exhaust gas temperature. Such measurements are directed to the digital displays on the control panel as well as to a personal computer (PC) data acquisition. Conducting experiments by PC data acquisition, as shown in Fig. 2, facilitates controlling and the measured values become directly available for further processing and evaluation.



Fig1. View of the Internal Combustion Engine (ICE)

Table 1 ICE Specifications

Design	Specification
Engine type	Spark ignition engine
Cooling	Air cooled
No. of cylinders	One cylinder
Configuration	External carburetion
Weight	17 kg approx.
Dimensions	515 x 345 x 370 mm (LxWxH)
Bore	65.1 mm
Stroke	44.4 mm
Length of the connecting rod	79.55 mm
Output power	1.5 kW approx.
Oil volume	0.6 liter
Ignition voltage	Magnetic ignition
Compression ratio	7:1

The exhaust emissions measurement system is carried out using a gas analyzer, as shown in Fig 3. The gas analyzer (model Infralyt CL) measures the concentration of CO, CO₂ and UHC in the exhaust gases on-line. Detailed specifications of the gas analyzer are presented in Table 2. The measuring scenario of exhaust emissions as well as engine performance is carried out as follows. The engine and gas analyzer were sufficiently warmed up for about 10 minutes. The engine was allowed to run until it reached to steady-state condition, and then, the data were collected subsequently. The engine output power and torque are measured by the eddy-current dynamometer. The engine is equipped with a temperature sensor to measure the exhaust gas temperature. The specific fuel consumption, SFC, volumetric efficiency, and engine pressure are

calculated online by the PC. The sampling of exhaust gases is taken on-line within the extension section of the exhaust pipe without any catalytic converter. For further details about experimental apparatus and methods, you may see [31].

During the tests, the engine did not show any starting difficulties when it was fueled by ethanol/gasoline blends, and it ran satisfactorily throughout the entire tests at room temperature. Due to the pulsed characteristics of the engine, the measurements were repeated three times and, in turn, the values were averaged for each operating condition. All tests of the blended fuels were completed without any modifications on the test engine and the tests were carried out under steady-state conditions.

Table 2 Specifications of the Gas Analyzer

Specifications	Value
Warm-up period	10 minutes
Dimensions	width: 294 mm depth: 430 mm height: 260 mm
Weight	approx. 9 kg
Exhaust gas temperature	5 - 45 °C
Emissions Measurement Range	CO 0-10 % vol CO ₂ 0-20 % vol UHC 0-2000 ppm vol (as C ₆ H ₁₄)
Power	230 V (+10%/-15%)
Frequency	50 +/- 1 Hz
Power consumption	Max. 45 VA
Range of apparatus heating	0-130°C

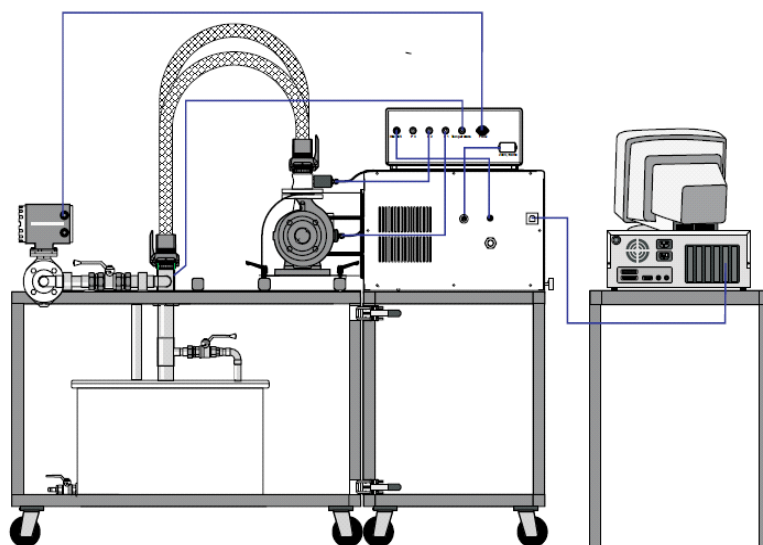

Fig. 2. Experimental Setup with PC

3. Results and discussions

In this study, unleaded gasoline was blended with ethanol to prepare four different blends on a volume basis. These are E0 (0% ethanol + 100% unleaded gasoline), E3 (3% ethanol + 97% unleaded gasoline), E7 (7% ethanol + 93% unleaded gasoline) and E10 (10% ethanol + 90% unleaded gasoline). The ethanol

used of 99% purity and the operation conditions were: the engine speeds vary between 2600 to 3500 rpm, throttle valves are at wide open throttle (WOT) condition. With these operation conditions, we can have a full understanding of the effects of the ethanol addition on the engine performance and pollutant emission.

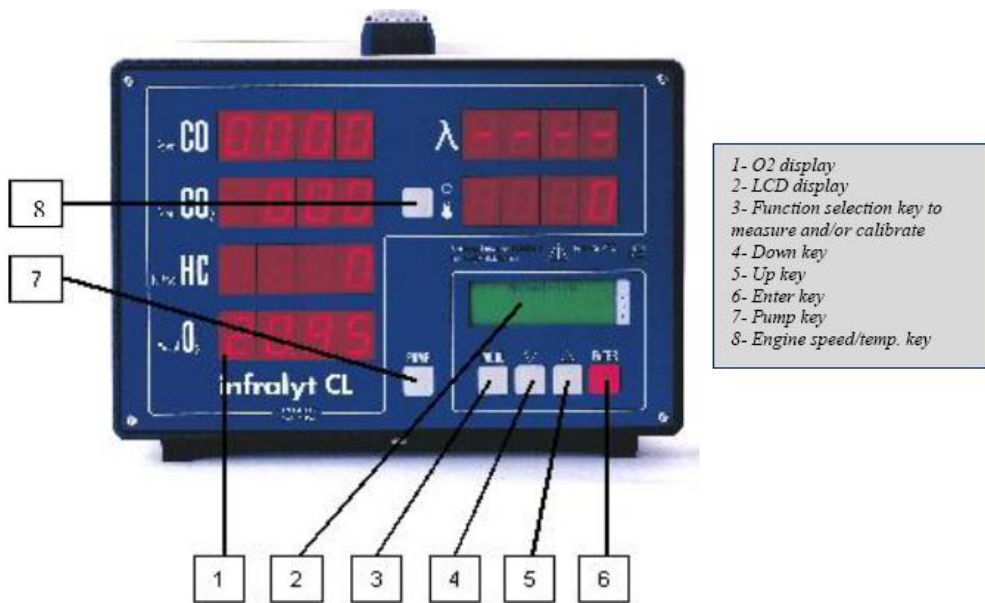

Fig 3. Gas Analyzer -Front View

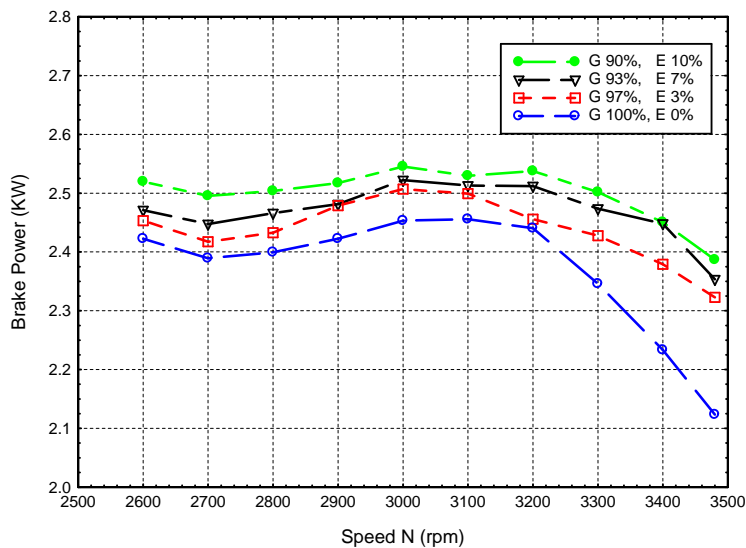

Fig.4. Brake Power versus Engine Speed

3.1 Performance results

The engine performance is generally evaluated by a lump of many factors as power, torque, efficiency and fuel consumption. In this study, the brake power, specific fuel consumption, torque, volumetric efficiency, exhaust gas temperature and P-V diagram were measured in a reasonable speed range, e.g., 2600-3500 rpm. Fig. 4 shows the brake power versus engine speed for the blended fuels (E3, E7, and E10) and neat gasoline (E0). The unleaded gasoline and all blends fuels are in the same trend. The engine power is maximum at moderate engine speed, but it is low at very low and very high engine speed, as standard. Compared to those of pure gasoline, the brake power increases by increasing of ethanol content in the blended fuel. The maximum brake power is obtained at E10, as shown in Fig 4.

Fig. 5 shows the specific fuel consumption (SFC) versus engine speeds. At all speeds, specific fuel consumption with the use of ethanol/gasoline blends has no major changes relative to that of the pure gasoline, as shown in Fig 5. However, for E10 SFC shows lowest values compared to E0, E3 and E7 for speeds lower than 2800 rpm as well as speeds higher than 3100 rpm. The maximum value of SFC was obtained at the 2900-3000 rpm in the E10 blended fuel. Indeed, this upward in SFC with the use of E10 is normal and it is due to the lower energy content of the ethanol. The heating value of ethanol is lower

than that of gasoline, both on a mass basis and on a volume basis [15, 32]. This means that the engine needs a higher amount of ethanol to produce the same power as in gasoline fueled engine. Thus, use of ethanol–gasoline fuel blends resulted a slightly increasing in the fuel consumption compared to the use of unleaded gasoline. This explanation is true for certain engine speed, however, at speed rang lower than 2800 rpm and speeds higher than 3100 rpm, SFC is low specially at E10 fuel. The reason for the decrease in SFC is the increase in the volumetric efficiency, as shown in Fig. 6 . When the volumetric efficiency increases, combustion efficiency increases and in turn, SFC decreases. As shown in Fig. 6, the volumetric efficiency decreases (for E10) sharply with speed range 2800-3100 rpm and, in turn, the SFC will increase at this speed range. It can also notice that for blended fuels (E3 and E7), the SFC is slightly lower than that E0 although the volumetric efficiencies of E0, E3 and E7 have no major differences. Ethanol has more oxygen rate than that of gasoline. More oxygen causes to increase the combustion efficiency, and this reduces SFC. Hence, although ethanol has lower heating value than gasoline, the SFC for E3 and E7 were lower than that of pure gasoline due to their high oxygen contents. Finally, it was noted that SFC depends on the engine speed rather than the ethanol content for ethanol less than 10% blended ratios.

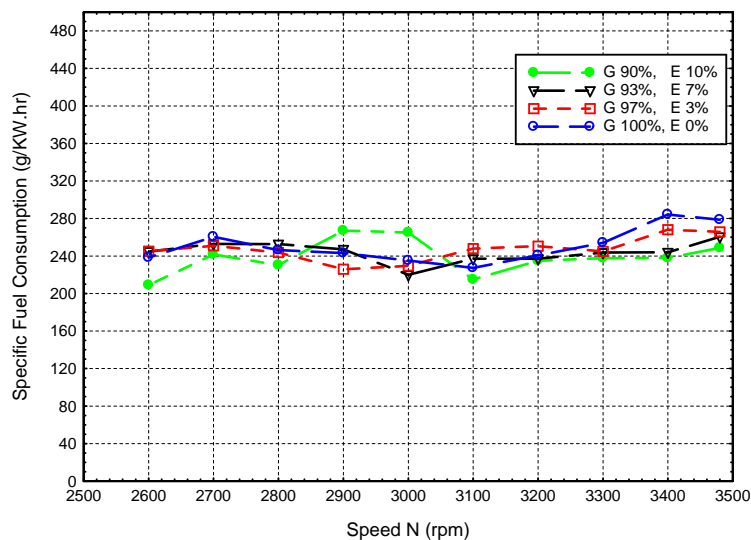

Fig.5. Specific Fuel Consumption (SFC) Versus Engine Speed

The brake torque versus engine speed for all the tested fuels is shown in Fig. 7. The results for the ethanol blends show a significant improvement in brake torque when compared to the pure gasoline fuel where the base fuel (E0) produces the lowest brake torque among all the engine speeds. At high engine speeds, e.g., 3400-3500 rpm, in case of further increase of ethanol content in the blended fuels will not cause major effect on the brake torque where all fuels did not show major differences. At low engine speeds, however, the ethanol blends (E3, E7 and E10)

performed considerably better brake torque than that neat gasoline fuel (E0). Generally, the results for the ethanol blends indicate an improving brake torque with the increasing ethanol ratio in the blends. The gain in the brake torque obtained with ethanol blends can be attributed to better anti-knock behavior of these blends and the improvement in the engine volumetric efficiency [33]. As shown in Figs. 4, 6 and 7, volumetric efficiency increases with the increasing brake power and torque.

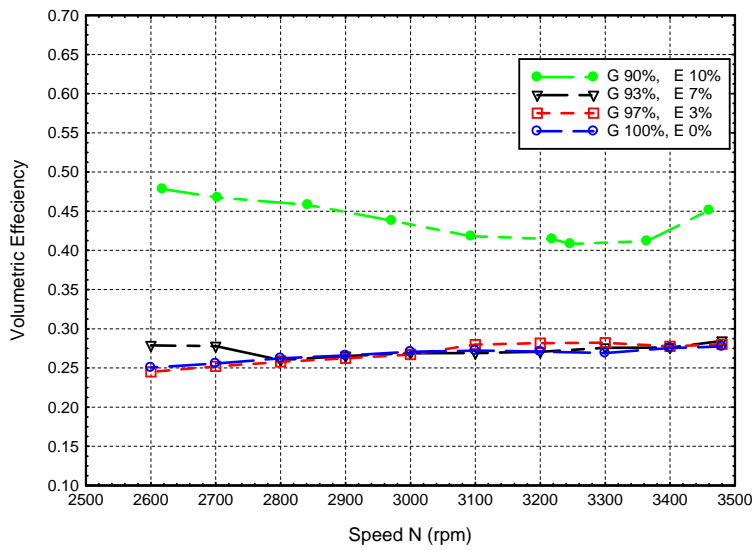

Fig.6. Volumetric Efficiency versus Engine Speed

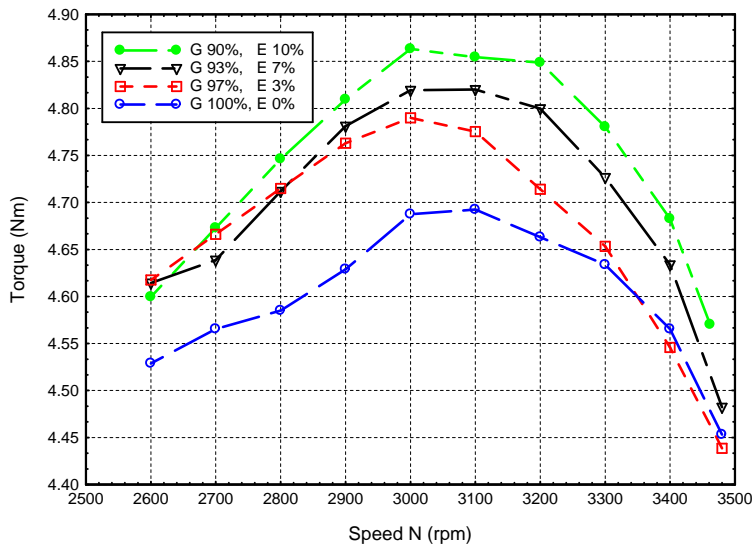

Fig.7. Torque versus Engine Speed

The change in the exhaust gas temperature (EGT) at different engine speeds and different blended fuels can be seen in Fig. 8. As shown, the exhaust gas temperatures increase as engine speeds increase. All blended fuels (E3, E7 and E10) produce slow increase of EGT at the engine speeds of 3000-3400 rpm, when compared to pure gasoline (E0). However, at the engine speeds of 2600-3000 rpm results show an opposite impact where E10 shows the greatest increase in the EGT. And also, the peak locations of the EGT of ethanol–gasoline blends are wider than that of pure gasoline. We may refer the trend of EGT

to that the EGT changes proportionally with the maximum cylinder temperature. Since ethanol has higher latent heat of vaporization than that of gasoline [34], the EGT for blends is lower than that of unleaded gasoline. This explanation is correct for the speed range 3000-3400 rpm, however, for speed range 2600-3000 rpm, E10 shows great increase in the EGT, as shown in Fig 8. The main reason for this situation is the great increase in torque, power and volumetric efficiency for E10 at this speed range, as shown in Figs. 4, 6 and 7.

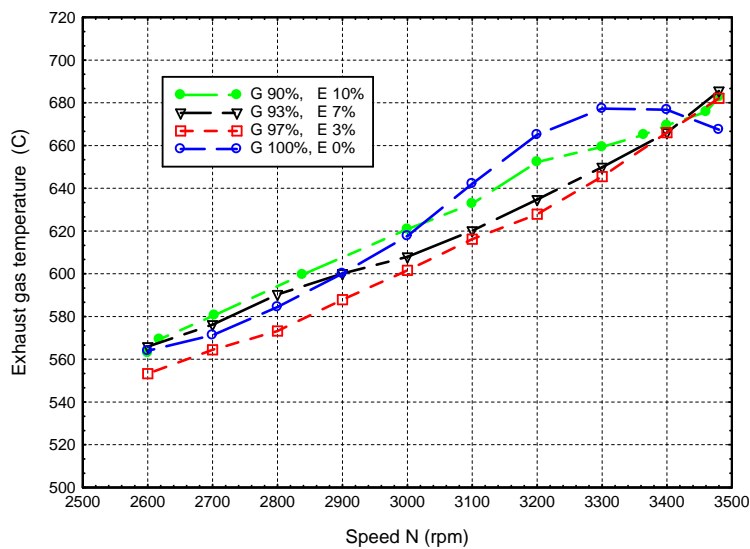

Fig.8. Exhaust Gas Temperature versus Engine Speed

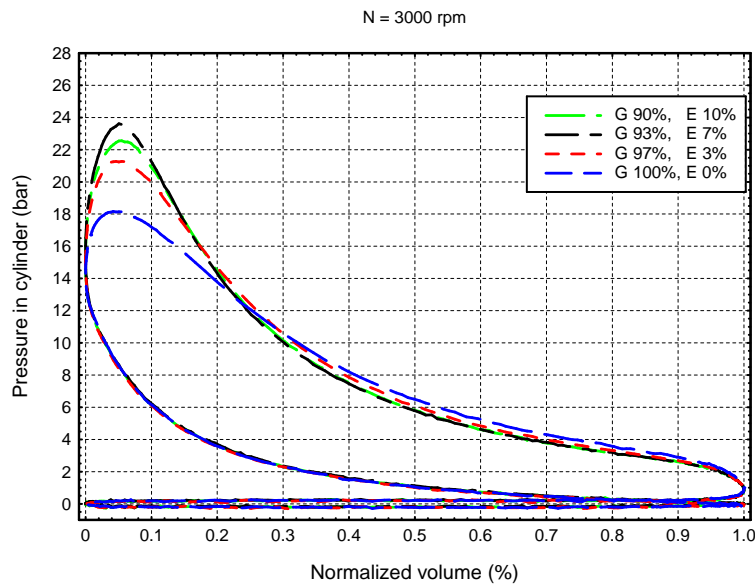

Fig.9. P-V Diagram

The combustion characteristics of ethanol blends can be compared with gasoline fuel by means of cylinder gas pressure. Fig. 9 shows comparisons of the cylinder gas pressures, for the test fuels, with cylinder normalized volume at the engine speed of 3000 rpm. As seen in the figure, the cylinder gas pressure with the use of pure gasoline is lower than that of all blended fuels especially at TDC. Furthermore, maximum pressure (Pmax) for all test fuels occurred closer to the top dead center (TDC). The cylinder gas pressure of ethanol–gasoline blends fuel is wider than that gasoline fuel. The reason for this may be explained with the longer combustion duration of ethanol–gasoline blends fuel. Another reason, the cylinder gas pressure increases with the increasing of torque, power and volumetric efficiency where more fuel is injected into cylinder.

3.2 Exhaust emission results

The exhaust emission results versus engine speeds are shown in Figs. 10-12. The effect of ethanol addition in the unburned hydrocarbons (UHC) exhaust gas emissions is shown in Fig. 10; as seen, the UHC decreases with increasing the ratio of ethanol in blends fuel. E10 shows the lowest UHC compared with that of E3 and E7 blends fuel. Similarly, at all engine speeds test, minimum CO emission was monitored with the use of ethanol–

gasoline blended fuels, as shown in Fig 11. The most significant reduction in CO and UHC emissions was obtained with the use of ethanol–gasoline blends at E10, E7 and E3, respectively. For all test fuels, a decreasing in UHC and CO emissions and an increasing in CO₂ emission took place with the increase of engine speeds as well as the ratio of ethanol in ethanol–gasoline blends. As shown in Figs. 10-12, while the unburned HC and CO emissions reduced, CO₂ emissions increased. This clarifies that the use of blended fuels leads to increase emissions of CO₂; this occurs because the process formation of CO₂ from the CO and UHC oxidation occurs efficiently, e.g., improved combustion. CO₂ is released into the atmosphere and this CO₂ is recycled into organic tissues during plant growth, e.g., it is not considered as pollutant emissions. However, CO and UHC are released into atmosphere due to the incomplete combustion of fuels and that influences on public health and environment. Besides, CO and UHC emissions in the exhaust gases are important because they represent lost in chemical energy that not fully utilized in the engine. Adding ethanol to gasoline leads to a leaner better combustion; the lean combustion improves the completeness of combustion and therefore the CO and UHC emissions were decreased. Finally, we may conclude that ethanol burns cleaner than regular gasoline and produce lesser carbon monoxide and UHC at all engine speeds.

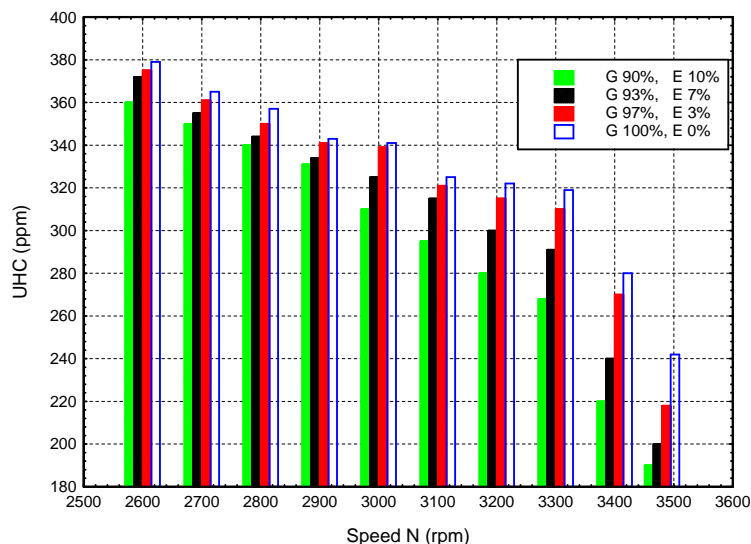

Fig.10. Unburned Hydrocarbons (UHC) Versus Engine Speed

4. Conclusions

The effect of using gasoline–ethanol blends on SI engine performance and exhaust emission is investigated experimentally. A four stroke, single cylinder SI engine was used for this study. Performance tests were conducted for volumetric efficiency, brake power, engine torque specific fuel consumption, exhaust gas temperature and cylinder pressure, while exhaust emissions were analyzed for carbon monoxide (CO), carbon dioxide (CO₂) and unburned hydrocarbons (UHC), using neat gasoline and gasoline-ethanol blends with different ratios of ethanol fuel at variable engine speeds, ranging from

2600 to 3500 rpm. The results showed that blending unleaded gasoline with ethanol increases the brake power, torque, volumetric efficiency, exhaust gas temperature and cylinder pressure, while it decreases the brake specific fuel consumption. The CO and UHC emissions concentrations in the engine exhaust decrease, while the CO₂ concentration increases. The 10% vol. ethanol in fuel blend gave the best results for all measured parameters at all engine speeds. Finally, this study may confirm the use of ethanol as promising octane blending biofuel with gasoline in modern and future gasoline engine technologies.

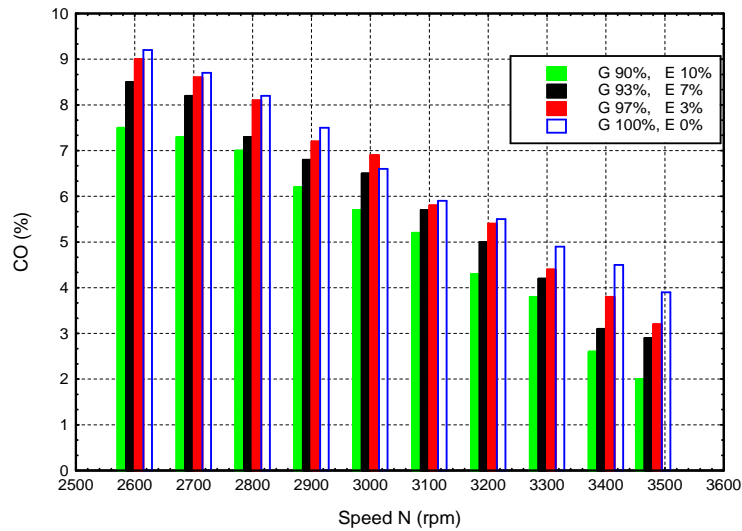

Fig.11. Carbon Monoxide versus Engine Speed

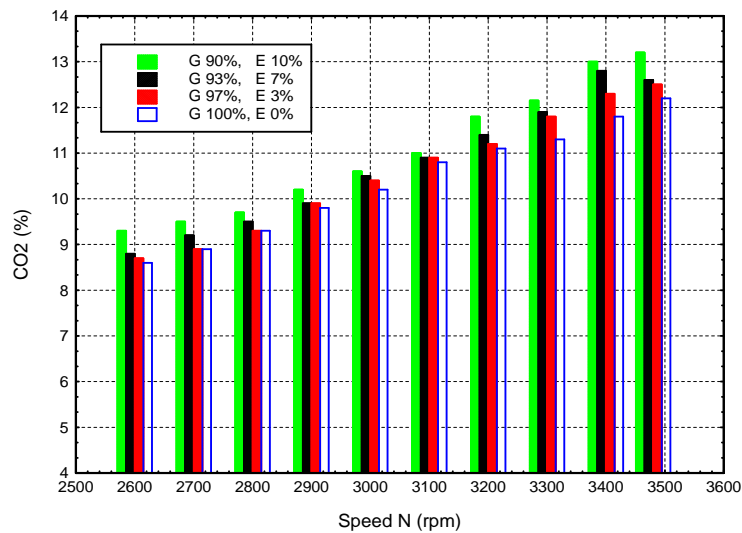

Fig.12. Carbon Dioxide Versus Engine Speed

References

- [1] A. N. Ozsezen, M. Canakci, Performance and combustion characteristics of alcohol-gasoline blends at wide-open throttle, *Energy*, vol. 36, pp. 2747-2752, 2011.
- [2] P. Mazza, Ethanol: fueling rural economic revival, *Climate Solutions Report*. 2001.
- [3] C. W. Wu, R. H. Chen, J. Y. Pu, T. H. Lin, The influence of air-fuel ratio on engine performance and pollutant emission of an SI engine using ethanol-gasoline blended fuels, *Atmospheric Environment*, vol. 38, 40, pp. 7093-100, 2004.
- [4] F. H. Palmer, *MI MechE*, Vehicle performance of gasoline containing oxygenates, C319/86, pp. 33-46, 1986.
- [5] K. J. Kelly, B. K. Bailey, T. Coburn, W. Clark, P. Lissiuk, Federal test procedure emissions test results from ethanol variable-fuel vehicle, Chevrolet luminas. SAE paper no: 990602, pp. 249-60, 1999
- [6] J. S. Cowart, W. E. Boruta, J. D. Dalton, R. F. Dona, F. L. Rivard, R. S. Furby, J.A. Piontkowski, R.E. Seiter, R.M. Takai, . Powertrain development of the 1996 Ford flexible fuel Taurus, SAE paper no. 952751, pp. 115-28, 1995.
- [7] R. M. Bata, A. C. Elrod, R.W. Rice, Emissions from IC engines fueled with alcohol-gasoline blends: a literature review, *Transactions of the ASME*, vol. 111, pp. 424-31, 1989.
- [8] M. Al-Hasan, Effect of ethanol-unleaded gasoline blends on engine performance and exhaust emissions, *Energy Conversion and Management*, vol. 44, pp. 1547-61, 2003.
- [9] M. Alexandrian, M. Schwalm, Comparison of ethanol and gasoline as automotive fuels, *ASME papers* 92-WA/DE-15, 1992.
- [10] H. S. Yucesu, T. Topgul, C. Cinar, M. Okur, Effect of ethanol-gasoline blends on engine performance and exhaust emissions in different compression ratios, *Applied Thermal Engineering*, vol. 26, pp. 2272-8, 2006.
- [11] T. Topgul, H. S. Yucesu, C. Cınar, The experimental investigation of the effect of ethanol-gasoline blends on engine performance in different compression ratios on a spark ignition engine, *Eighth international combustion symposium*. Ankara, Turkey; September, 8-9, 2004
- [12] M. B. Celik, Experimental determination of suitable ethanol-gasoline blend rate at high compression ratio for gasoline engine, *Appl. Therm. Eng.*, vol. 28, pp. 396-404, 2008.
- [13] A. K. Agarwal, Biofuels (alcohols and biodiesel) applications as fuels for internal combustion engines, *Prog. Energy Comb. Sci.*, vol. 33, pp. 233-71, 2007.
- [14] R. W. Rice, A. K. Sanyal, A. C. Elrod, R. M. Bata, Exhaust gas emissions of butanol, ethanol and methanol-gasoline blends, *Journal of Engineering for Gas Turbine and Power*, vol. 11, pp. 337-381, 1991.
- [15] W. D. Hsieh, R. H. Chen, T. Wu, T. Lin, Engine performance and pollutant emission of an SI engine using ethanol-gasoline blended fuels, *Atmospheric Environment*, vol. 36, 3, pp. 403-410, 2002.
- [16] H. Bayraktar, Experimental and theoretical investigation of using gasoline-ethanol blends in spark ignition engines, *Renewable Energy*, vol. 30, pp. 1733-47, 2005.
- [17] B. Q. He, J. X. Wang, J. M. Hao, X. G. Yan, J. H. Xiao, A study on emission characteristics of an EFI engine with ethanol blended gasoline fuels, *Atmospheric Environment*, vol. 37, pp. 949-57, 2003.
- [18] A. Abdel-Rahman, M.M Osman, Experimental investigation on varying the compression ratio of SI engine working under different ethanol-gasoline fuel blends, *Energy Research*, vol. 21, pp. 31-40, 1997.
- [19] R. Cataluna, R. da Silva, E. w. de Menezes, R. B. Ivanov, Specific consumption of liquid biofuels in gasoline fuelled engines, *Fuel*, vol. 87, pp. 3362-8, 2008.
- [20] T. Topgül, H. Yücesu, C. Çınar, A. Koca, The effects of ethanol-unleaded gasoline blends and ignition timing on engine performance and exhaust emissions, *Renew Energy*, vol. 31, 15, pp. 2534-42, 2006.

- [21] D. A. Guerrieri, P. J. Caffrey, V. Rao, Investigation into the Vehicle Exhaust Emissions of High Percentage Ethanol Blends, SAE, 85–95, 1995.
- [22] A. M. Pourkhesalian, A. H. Shamekhi, F. Salimi, Alternative fuel and gasoline in an SI engine: A comparative study of performance and emissions characteristics, *Fuel*, vol. 89, pp. 1056–1063, 2010.
- [23] C. de Melo, B. Machado, R. T. Machado, J. P. Belchior, P. Pereira, Thermodynamic modeling of compression, combustion and expansion processes of gasoline, ethanol and natural gas with experimental validation on a flexible fuel engine, SAE World Congress, pp. 24-35, 2007
- [24] G. Najafi, B. Ghobadian, T. Tavakoli, D. R. Buttsworth, T. F. Yusaf, M. Faizollahnejad, Performance and exhaust emissions of a gasoline engine with ethanol blended gasoline fuels using artificial neural network, *Applied Energy*, vol. 86, pp. 630–639, 2009.
- [25] M. Eyidogan, A. N. Ozsezen, M. Canakci, A. Turkcan, Impact of alcohol–gasoline fuel blends on the performance and combustion characteristics of an SI engine, *Fuel*, vol. 89, pp. 2713–2720, 2010.
- [26] B. Cahyono, R. Abu Bakar, Effect of Ethanol Addition in the Combustion Process During Warm-UPS and Half Open Throttle on Port-Injection Gasoline Engine, *American J. of Engineering and Applied Sciences*, vol. 4, pp. 66-69, 2011.
- [27] J.S. MacDonald, Evaluation of the hydrogen supplemented fuel concept with an experimental multi-cylinder engine, SAE technical paper. 1976, 760101.
- [28] N. Jeuland, X. Montagne, Potentiality of ethanol as a fuel for dedicated engine, *Gautrot. Oil Gas Sci Technol*, vol. 59, pp. 559–70, 2004.
- [29] C. Park, Y. Choi, C. Kim, S. Oh, G. Lim, Y. Moriyoshi, Performance and exhaust emission characteristics of a spark ignition engine using ethanol and ethanol-reformed gas, *Fuel*, vol. 89, pp. 2118–2125, 2010.
- [30] C. L. Song, W. M. Zhang, Y. Q. Pei, G. L. Fan, G. P. Xu, Comparative effects of MTBE and ethanol additions into gasoline on exhaust emissions, *Atmosp. Environ*, vol. 40, pp. 1957-1970, 2005.
- [31] A. Elfakhany, Investigation on performance and emissions characteristics of an internal combustion engine fuelled with petroleum gasoline and a hybrid methanol–gasoline fuel, *IJET-IJENS*, vol. 13, pp. 24-43, 2013.
- [32] K. Mustafa, Y. Sekmen, T. Topgu, H. S. Yucesu, The effects of ethanol–unleaded gasoline blends on engine performance and exhaust emissions in a spark-ignition engine, *Renewable Energy*, vol. 34, pp. 2101–2106, 2009.
- [33] Z. Mouloungui, G. Vaitilingom, J.C. Berge, P.S. Caro, Interest of combining an additive with diesel ethanol blends for use in diesel engines, *Fuel* vol. 80, pp. 565–74, 2001.
- [34] J. B. Heisey, S. S. Lestz, Aqueous alcohol fumigation of a single-cylinder DI Diesel engine, SAE technical paper 811208, 1981.