

Optimization Gear Oil Pump in Order to Energy Saving and Environmental Impact in a Diesel Engine

A. R. Noorpoor¹

1. Associate professor, Graduate Faculty of Environment, University of Tehran (UT), Iran

Abstract

Oil pump in diesel engine has significant effect on energy consumption and environment pollution. In this paper, the modeling and simulation of a gear oil pump used in a diesel engine and its fluid flow analysis by a solver has been explained. Also the optimization and redesign of it has been discussed and then the outcomes have been compared with the experimental and previous results. The type of this oil pump is external gear pump with involute tooth profile, so we need to use the gears with the minimum number of tooth to optimize the pump performance and getting the optimum displacement volume rate of it. While the engaged gears of the pump rotating together, the intersection between them changes in time. So their boundaries should be considered as movable. The strategy used here consist in using dynamic meshes, dividing a tooth rotating cycle into a certain number of time steps and investigating the flow and getting the results for each time steps.

Keywords: *external gear oil pump, fluid flow, moving boundary, Dynamic mesh, involute profile.*

1. Introduction

When we talk about the hydraulic systems, at least an oil pump for supplying the required oil pressure and displacement volume is needed. Also we need an oil pump for supplying the lubrication of the parts which are in contact to each other with very high speeds in the vehicles. Among all types of the pumps which are in use in hydraulic industries, external gear oil pumps are the most common type because of its simple structure, well made, economy and the ability in supplying high oil pressures and displacement volumes. It is essential to use a high ability lubrication system in order to have safe performance of a diesel engine under heavy circumstance. So for optimization of such pumps, the process of numerical simulation and the analysis of flow in them seem very necessary and useful [1].

It is used a special algorithm and method for simulating an external gear pump with 11 teeth. The strategy used there consist in dividing a cycle in to a certain number of time steps, obtaining different computational meshes for each these time steps and coupling between two consecutive time steps by interpolating the flow unknowns in them [2]. Also in the study, have been shown that there is a small difference between the simulation of the pump as 2D and 3D by comparison of their analysis results and in

fact the flow of the pumps is as 2D. K. Nagamura et al. have developed a method for calculating the exact displacement volume rate of the pump with the various type of gear profile among involute tooth profile and the relations have been presented in it [3]. It is presented some relations for calculating the displacement volume rate of the pump too [4]. A fictitious domain method presented to solve a lobe pump, which exhibits the same geometrical difficulty as the gear pump we have in hands. In the fictitious domain method, the positions of the lobes are identified by turning on and turning off the elements that are in the fluid and inside the lobes, respectively, at each time step. The boundary condition on the lobe boundaries are imposed in a weak way by introducing a Lagrange multiplier [5]. Riemsloagh K et al. used an Arbitrary Lagrangian Eulerian (ALE) method. Similarly, Hughes TJ. et al. [7] and Huerta A. et al. [8] used to follow the rotation of the gears of a lobe and a gear pumps. However, the automatic remeshing technique they adopt does not enable a perfect control on the mesh, which can be un circumvent able if one wants to accurately solve the gap and the intersection of the gears. Also some works and papers has been used for editing the study which has been noted in references.

2. structure of the external gear pump

The external gear pumps are categorized in positive displacement pumps and are belong to rotary pumps. In these pumps, two gears which are engaged to each other are surrounded in housing.

In general, the gears could be built in two curvature profile type named Involute and Cycloid profile or combination of them. But while the gears with the Involute tooth profile are produced easily and the technology is used for producing the types of power train gears, so the profile usually is used in external gear pumps. If we assume that all the fluid trapped between the teeth is delivered to out port (no leakage), the volume flow rate Q (mm^3/s) provided by the pump is directly proportional to the velocity of rotation ω (rad/s) of the gears. The constant of proportionality is called the volumetric constant and is referred to as C_v (mm^3/rad) as follow:

$$Q = C_v \omega \quad (1)$$

The number of gear teeth should be low enough in order to the suitable volume rate in the gear pumps, thus for supplying a smooth and low noise performance, a modified addendum system with an involute profile must be used in them. In fact most of the producers use the gears with 7 to 12 teeth at each gear in the external gear pumps. The main pump which first had been used in the engine has the two same gears with 7 teeth and module of 4.5. The speed rotation of the gears is about 1100 rpm which is half value of the motor.

One of the main goals of this work consists in estimating the pressure distribution and its counters

within the suction side to investigation cavitation. Cavitation is mainly due to vaporization of the oil or the pressure of air in it. Vaporization occurs when the pressure is too low or the temperature is too high. Low pressure can occur for two main reasons. The first reason is an insufficient inlet pressure (in our case the atmospheric pressure if the tank is at the same level). If this is the case, the depression needed to suck in the fluid and overcome the pressure losses from the tank can be propitious to the onset of vaporization. The second reason could be presence of a highly swirling flow, which characteristic high velocities are accompanied. Cavitation affects the pumping capability of the pump as the gear cavities are not filled completely with oil. In fact, the scenario is worse, as once cavitation has occurred, a subsequent increase of pressure provokes the collapses of the vapor bubbles. The resulting compression waves contribute to the erosion of the structure and generation of high level noise. It should be noted that the phenomenon seldom occurred in the pumps because of a low saturated pressure of the oil except in the cases of very high drop pressures. Therefore the main goal of the study is to investigate of the main pump geometry and the improvement of efficiency. In fact in this study, the fluid displacement capability (volume flow rate) has been increased by decreasing the gear teeth number from 7 to 6 and increasing the space between the teeth and casing and the flow within the pump has been analyzed by simulating it. The diagram of the modified pump has been shown in figure (2).

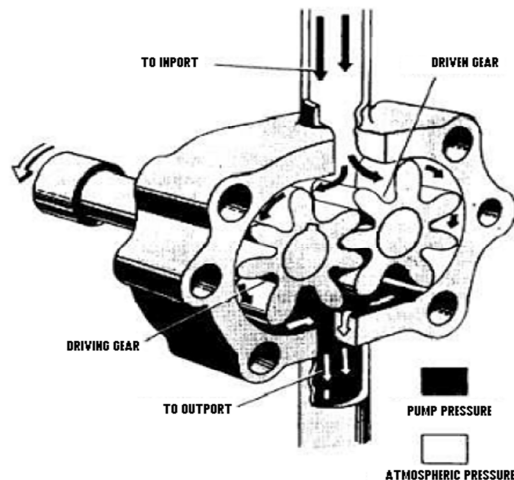

Fig1. Schematic diagram of main external gear pump with 7 teeth [1]

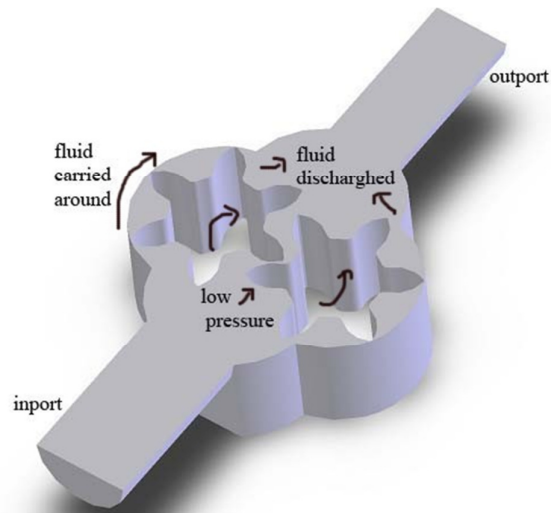

Fig2. Schematic diagram of modified external gear pump (6 teeth) (only half pump)

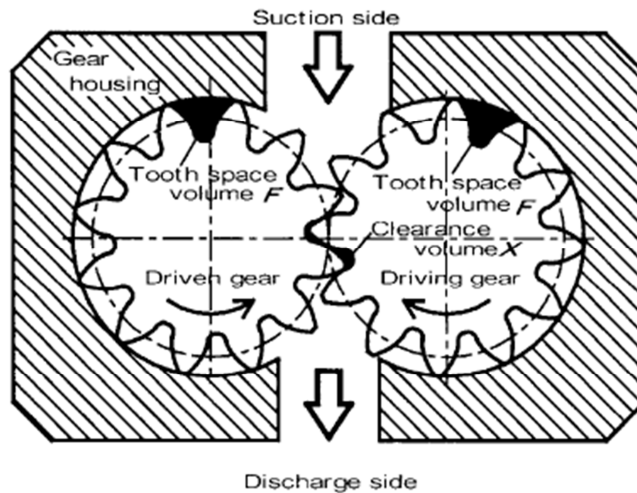

Fig3. Schematic diagram of an external gear pump and its free spaces as 2D [4]

3. Calculation method for displacement volume

Figure (3) shows a schematic diagram of an external gear pump as 2D. In the case of the external gear pump, the fluid in the suction side is delivered to the discharge side through the space between the gear housing and the tooth space clearance with the gear rotation. However the clearance volume returns to the suction side from the discharge side through the meshing point of the gear pair. Therefore, the displacement volume per one revolution, V_r , is expressed as [21]:

$$V_r = (2F - X_{min}) \times z \tag{2}$$

Where F is the tooth space volume, X_{min} is the minimum value of the clearance volume and z us the number of teeth. For the involute tooth, the displacement volume of the external gear pump has been calculated using the following equation, which was developed by Ichikawa [22]:

$$V_r = \frac{\pi b m^2}{2} \{ [z + 2 + 2(y - x)]^2 - (z + y)^2 - \frac{\pi^2}{3} (\cos \alpha_0)^2 \} \tag{3}$$

Where b is the face width, m is the module, x is the addendum modification coefficient, y is the center distance modification coefficient and α_0 is the cutter pressure angle. However, equation (3) is not very

accurate because the root fillet trochoid is assumed to be a straight line, as shown in figure (4). Therefore it is better that the tooth space clearance and the clearance volume are calculated by the numerical integration and the displacement volume is obtained using these values.

As an example, the coordinate system for calculating the volume of tooth space of an involute gear is shown in figure (5). The tooth profile of the involute gear is composed of three positions, namely

tip circle, involute and fillet trochoid. These portions are expressed as follows:

a) Tip circle:

$$\begin{aligned} X &= r_a \sin \gamma \\ Y &= r_a \cos \gamma \end{aligned} \tag{4}$$

Where γ is the angle as defined in figure (5) and r_a is the tip circle radius.

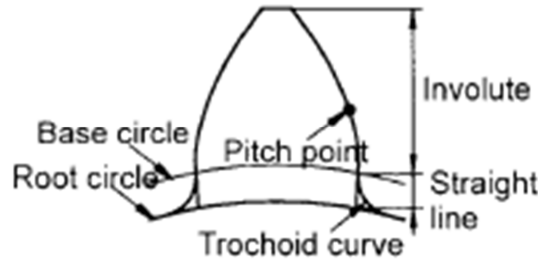

Fig4. Diagram of an involute tooth profile

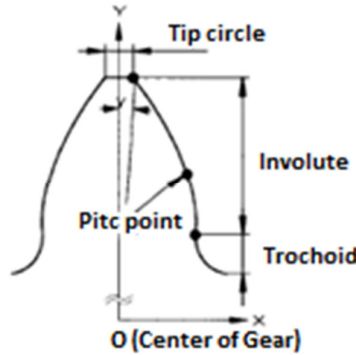

Fig5. Coordinate system of an involute tooth profile

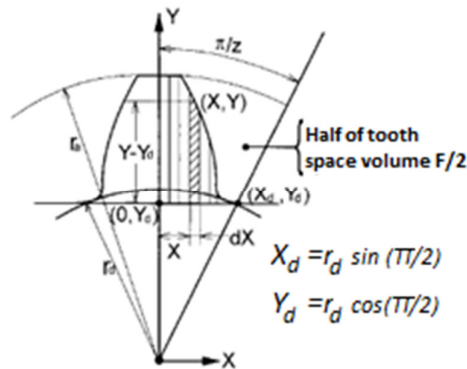

Fig6. The Schematic diagram of an involute tooth for calculating the space tooth

b) Involute:

$$X = (\sin \theta_i - \theta_i \cos \theta_i)r_b \cos \Theta - (\cos \theta_i + \theta_i \sin \theta_i)r_b \sin \Theta$$

$$Y = (\sin \theta_i - \theta_i \cos \theta_i)r_b \sin \Theta + (\cos \theta_i + \theta_i \sin \theta_i)r_b \cos \Theta \quad (5)$$

Where θ_i is the involute angle, r_b is the base circle radius and Θ is given by:

$$\Theta = \tan \alpha_0 - \alpha_0 + \frac{\pi + 4x \tan \alpha_0}{2z} \quad (6)$$

c) Tooth fillet trochaic:

$$X = \frac{(r - h_0) \sin(\xi + u) - r \xi \cos(\xi + u) - r \xi \cos(\xi + u) + h_0 \sin(\xi + u)}{\sqrt{h_0^2 + r^2 \xi^2}} r_0$$

$$Y = \frac{(r - h_0) \cos(\xi + u) + r \xi \sin(\xi + u) - r \xi \sin(\xi + u) - h_0 \sin(\xi + u)}{\sqrt{h_0^2 + r^2 \xi^2}} r_0 \quad (7)$$

Where r is the pitch circle radius, r_0 is the round edge radius of the basic rack, h_0 is the distance between the center of the round edge and pitch line on the basic rack, and u is determined by:

$$u = \frac{\pi + 4x \tan \alpha_0}{2z} + \frac{h_0 \tan \alpha_0}{r} + \frac{r_0}{r \cos \alpha_0} + \frac{j_n}{r \cos \alpha_0} \quad (8)$$

Where j_n is the normal backlash [23]. The backlash does not affect significantly the calculation of the displacement volume. Using above equations, the coordinate values X and Y on the tooth profile and the tooth space volume were calculated by the numerical integration.

From figure 6, the tooth space volume can be calculated from:

$$F = 2 \left[\frac{\pi r_a^2}{2z} - \frac{X_d Y_d}{2} - \int_0^{X_d} (Y - Y_d) d \right] \quad (9)$$

Where r_a is the tip circle radius, r_d is the root circle radius, and z is the number of teeth.

Figure (6) shows the clearance volume, which is determined as gear pair contact. As seen in this figure, the clearance volume changes with gear rotation, and it has the minimum value at the middle of meshing. The clearance value is also calculated by the numerical integration using the above equations as well as the tooth space volume. The displacement volume of gear pump can be computed by substituting the tooth space volume and the minimum clearance volume into equation (2). Also, the displacement volume can be calculated by Little[4] equation which is accurate in compare with Ichikawa equation as follow:

$$Q = \frac{\pi b m^2}{2} \left[(z + 2(x + 1))^2 - z^2 (\cos \alpha)^2 (\sec \alpha_w)^2 - \frac{\pi^2 (\cos \alpha)^2}{12} \right] \quad (10)$$

Where b is the gear width, x is the modification addendum coefficient, m is the gear module, α_w is the difference of pressure angle, z is the gear tooth and α is pressure angle.

Recently numerical approaches by means of computational fluid dynamics (CFD) has been developed for studying the effect of cavitation in the volumetric efficiency, increasing flow rate and pressure drop of gear pumps [24] , [25].

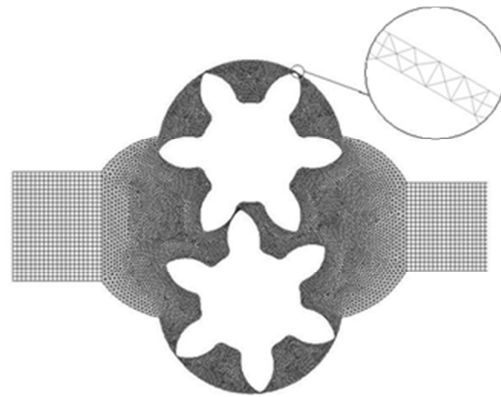

Fig7.Grid generation in physical domain

4. Geometry and meshing of the external gear pump

Figure (7) shows an asymmetric section of the modified pump and its grid. If the pump is so well made that the distances between teeth and casing was too slight and the existent leakage can be neglected, we can divide the pump to two separated parts as suction and discharge. Thus the analysis of the pump as the manner make it very easy. But unfortunately we cannot use the manner because of the very high pressure in the pumps.

According to the figure (7), the structural meshes have been used in the grid of the outlet and inlet sections and the triangular meshes have been used in the grid of the pump housing. The pump housing grid has been smaller in areas near the gears than the other meshes. The grid should be enough slight because of the turbulence flow in this areas. So we use a grid with 162792 meshes in it. Also the grid of the area between a tooth and the casing has been shown in the figure.

5. Governing equations and boundary conditions

In the external gear pumps, we meet to a periodic flow which its parameters have been repeated in gear to next gear rotating distances because of the periodic transportation of fluid packages that trapped between the casing and the teeth and thus we meet to an unsteady flow. The hydraulic pumps such as external gear pumps, often work with the high viscosity fluids. So according to equation (11) we face to the rather low Reynolds compare with the other pumps in expect of the areas which the velocity is very high in them.

$$Re = \frac{\rho VL}{\mu} \quad (11)$$

It should be noted that generally the head height of the positive displacement pumps is high but their velocity is lower than the other pumps such as turbo machines. So the flow of the pumps is mainly laminar in expect of a few parts near the gears. However, we use the K- ω turbulent model to analysis of the flow regarding to existing flow turbulence in some part of it. Continuity or mass survival equation govern on fluid flow is as follow:

$$\frac{\partial \rho}{\partial t} + \frac{\partial}{\partial x_i} (\rho u_i) = 0 \quad (12)$$

The above equation will be transformed regarding to the incompressibility of oil:

$$\frac{\partial u}{\partial x} + \frac{\partial v}{\partial y} = 0 \quad (13)$$

Then the governing Navier-Stock equation is as [2]:

$$\rho \partial_t u + \rho (u_a \cdot \nabla) u - 2\mu \nabla \cdot \varepsilon(u) + \nabla p = 0 \quad (14)$$

Where $\varepsilon(u)$ is the rate of deformation tensor given by:

$$\varepsilon(u) = \frac{1}{2} (\nabla u + \nabla u^t) \quad (15)$$

Since the inlet part of the pump is fed from the tank which its pressure is atmosphere pressure so the entrance boundary condition should be considered as atmospheric inlet pressure. Also the outlet boundary condition has been considered as outflow because of the developed flow in the part.

6. Optimization of the gear oil pump

The gears of the main oil pump that has been used in the first motor is 7 teeth its module and as a result its pitch diameter are respectively 4.5 and 31.5mm. Also the gears width is 54mm. the fluid which has been used in the pump is the oil with the flowing specifications: $\mu = 3 \times 10^{-5} \text{ kg/mms}$ $\rho = 9 \times 10^{-7} \text{ kg/mm}^3$

The pump displacement volume rate, according to the equation (10) which has been noted in the section (2), is about 68 Lit/Min. the displacement volume rate has been calculated based on the trapped areas between the casing and the teeth and according to the method that has been presented in the section (2) and its value is about 64 Lit/Min (without considering the flow leakages). Since we need to increase the pump displacement rate, therefore we should increase the teeth free space and consequently the tooth should be selected as the least number possible. Considering the tooth profile of the pump gears is as involute, so we need to select the least number of teeth which have the ability of producing of the tooth profile. Also it should be considered that the gears contact coefficient decrease with reduction of the gear teeth number and it should be noted in the design that its value not to be from 1.2. Therefore according to the investigations by the Mechanical Desktop software, it has been specified that the least teeth number which have the ability of making the profile is 6 teeth. A modified short addendum system has been used in the gears which its modified coefficient and module are respectively 0.15 and 5. The diagram of the modified pump has been shown in figure (9).according to the figure, considering the trapped areas between the teeth and casing and based on the section (2) method, the pump displacement volume rate increase to 81 Lit/Min which is about 25% increase in it. Its value

calculated about 80 Lit/Min by the equation (10). The trapped area between the tooth and casing is about 78 mm² in first pump and 109mm² in the modified pump which has been shown in figures (8) and (9) as hatched.

So the pump volume rate and consequently its performance have been improved without changing in the casing and only with changing the teeth number and profile. In the next step, the fluid flow in the pump has been investigated and analyzed by simulating the pump geometry and solving it by a solver. Then its result has been educed and noted in the next section.

7. Analysis results and validation

Since the engine speed is 2200 rpm and the motor is connected to the pump driving gear by some gears with ratio 2 to 1 so rotating speed of the pump gears is 1100 rpm and consequently required time for a complete round of gear rotation is about 0.054s. Considering the flow of gears pumps is periodic and repeated in the distances of gears rotation thus it is expected that the fluid flow has 6 flow cycles in a complete round of gears rotation. Flow specifications have been investigation in 2 points Q (before the gears near the teeth) and R (after the gears near the teeth) and based on the noted boundary conditions which have been shown in figure (9). The flow analysis results have been shown in figures (10) to (14)



Fig8. Geometry of the old gear oil pump (7 teeth)

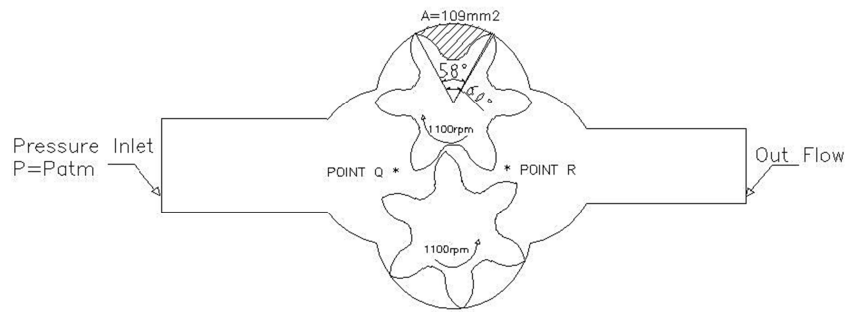

Fig9. Geometry of the modified gear oil pump (6 teeth)

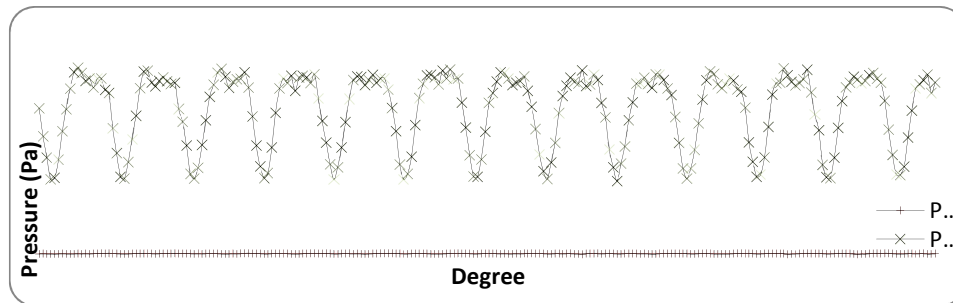

Fig10. Pressure versus the degree of gear rotating in the points Q (before gears) and R (after gears)

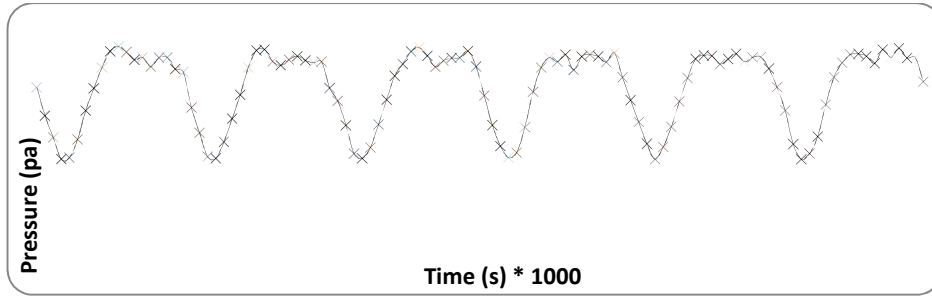

Fig11. Pressure versus the time of gear rotating in the point R in duration of a complete revolution

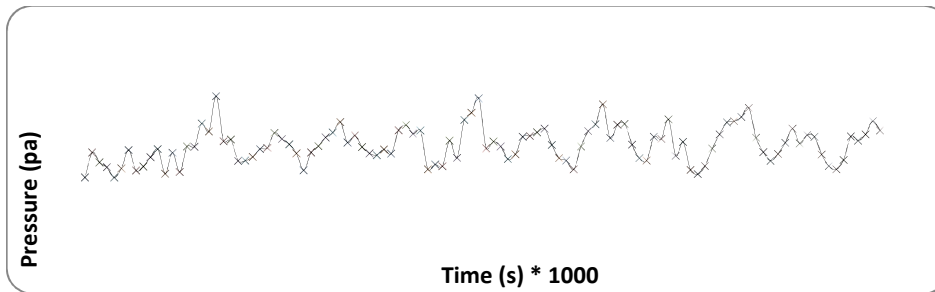

Fig12. Pressure versus the time of gear rotating in the point Q in duration of a complete revolution

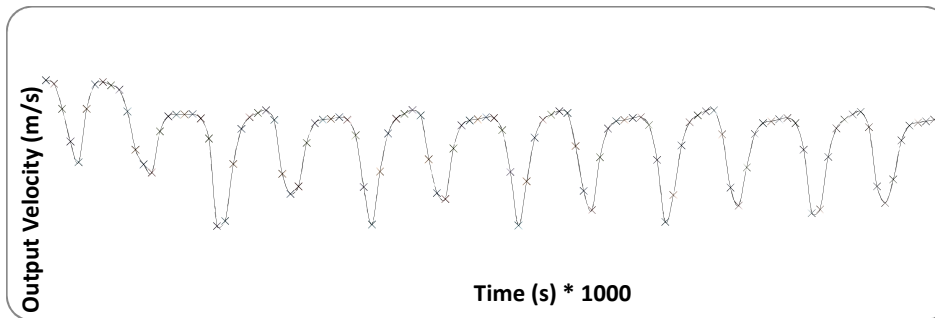

Fig13. Velocity versus the time of gear rotating in the point R in duration of a complete revolution

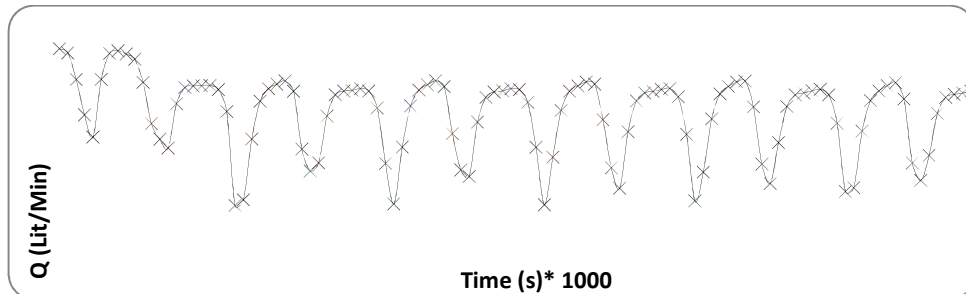

Fig14. Outlet displacement volume rate versus the time of gear rotating in duration of a complete revolution

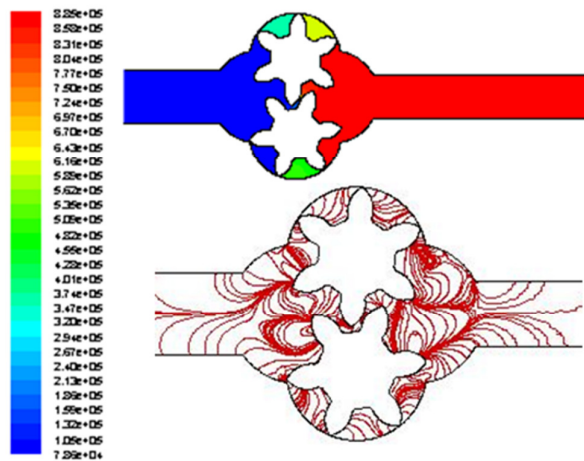

Fig15. Pessure contours (Pa) in the maximum outlet pressure status



Fig16. Test setup of external gear pump

As shown in the figures (10) to (14), the 6 flow cycles in a complete round of gears rotation and flow periodic are obviously recognizable. It should be noted that using the moving meshes involve existing a small space between the engaged teeth which cause some added leakage in some times of gears rotation and decrease the fluid pressure and velocity in them. The positions are clearly shown in the figures. According to the data obtained from the figures, the maximum of outlet pressure is about 8.6 bar and its average is 7.9 bar. Also the average of outlet displacement volume rate is about 79 Lit/Min which

confirm the results of equations calculations considering the added leakages in the cases. The diagram of flow pressure contours in the maximum pressure position has been shown in figure (15). The data has been obtained by the test unit which has been shown in figure (16). The diagram of flow velocity contours have been shown in figure (17). Since the fluid flow is periodic and repeats in the rotating distances of the gears, so the time interval has been divided to 3 parts and the contours has been obtained in them.

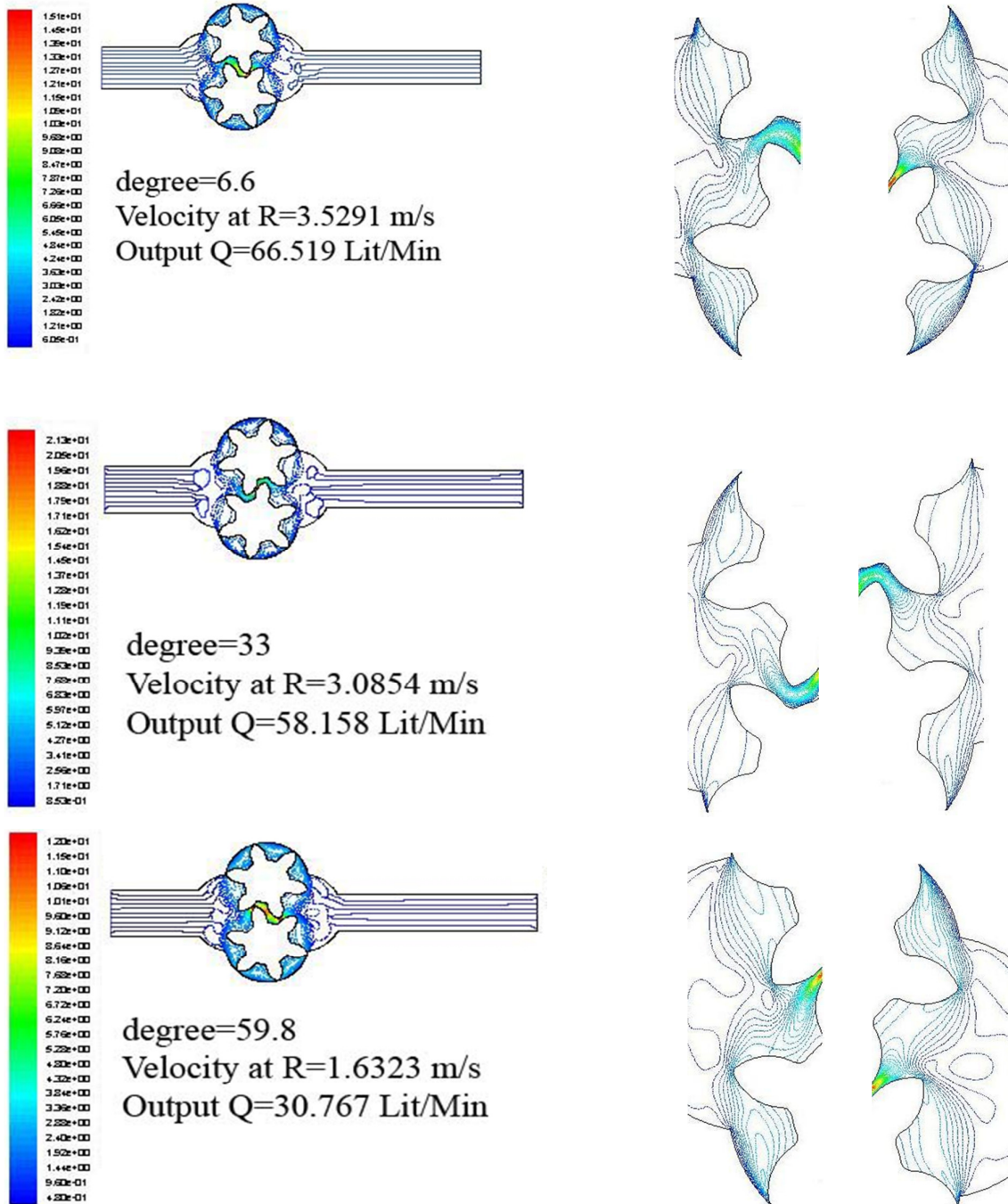

Fig17. Velocity contours (m/s) in the 3 divided parts of a gear rotating cycle

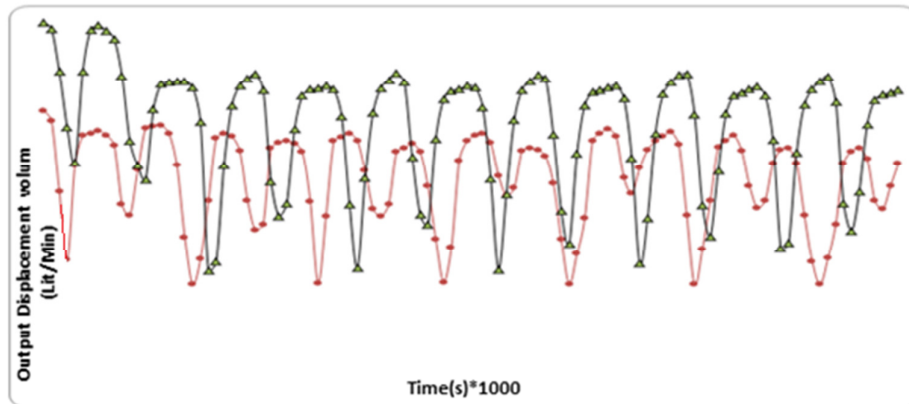

Fig18. Comparative diagram of the outlet displacement volume rate versus the time of gear rotating in duration of a complete revolution for the old pump and the modified pump

8. Conclusions and Discussions

In this study, the pump displacement volume rate and its performance has increased about 25% by the reduction of teeth number of gears from 7 to 6. The modification of gears teeth profile and increasing the trapped areas between the teeth and the casing of a diesel motor external gear oil pump cause improve the engine cooling and increase thermal efficiency. Increasing thermal efficiency is related to energy saving and impacts on environmental pollution reduction. The comparable diagram of the output pump displacement volume for both the main first pump and the modified pump has been shown in figure (18).

Also the flow specifications have been supplied by simulating the pump using the moving and dynamic grid method with a solver and the investigation of fluid flow in them. In fact the nature of being flow periodic and repetition of the flow specifications in the rotating distances between teeth to the next teeth have been shown obviously and the variations of flow pressure and velocity are observable in them. It should be noted that the number of flow cycles in a complete revolution of gears rotation is equal to the teeth number and this concern is clearly obtained from the diagrams. Also the issue has been shown from the figures that the flow pressure and displacement volume rate have been dropped quickly with increasing the leakage in order to increasing of the engaged teeth distance.

References

- [1]. Nam Kyung-Woo, Jo Sok-Hyun and Park Jae-In., "Numerical Simulation in the IC Engine Lubricating Gerotor oil pump", Journal of Korean Society of precision Engineering, 23 (2) 88-96, 2006.
- [2]. Houzeaux G, Codina R. "A finite element method for the solution of rotary displacement pumps International Center for Numerical Methods in Engineering (CIMNE)", Edificio C1, Campus Nord UPC, Gran Capita` s/n, 08034 Barcelona, Spain,2006.
- [3]. K Nagamura; K Ikejo, F G Tutulan, "Design and performance of gear pumps with a non-involute tooth profile", Proceedings of the Institution of Mechanical Engineers, 218, B7; ProQuest Science Journals pg. 699, 2004.
- [4]. Igor J.Karassik,William C.Krutzsch, "Pump hand book", McGraw-Hill Book Company.
- [5]. Voorde JV, Vierendeels J, Dick E., "Flow simulations in rotary volumetric pumps and compressors with the fictitious domain method", J. of Comput Appl Math.,168:491-9, 2004.
- [6]. Riemslogh K, Vierendeels J, Dick E., "An arbitrary Lagrangian-Eulerian finite-volume method for the simulation of rotary displacement pump flow", Appl Numer Math, 32:419-33, 2000.
- [7]. Hughes TJ, Liu W, Zimmerman T., "Lagrangian-Eulerian finite element formulation for incompressible viscous flows", CMAME;29:329-49, 1981.
- [8]. Huerta A, Liu W., "Viscous flow with large free surface motion", Comput Meth Appl Mech Eng, 69:277-324, 1988.
- [9]. Houzeaux G, Codina R., "A finite element model for the simulation of lost foam casting", Int J Numer Meth Fluids,46:203-26, 2004.
- [10]. Spalart P, Allmaras S., "A one-equation turbulence model for aerodynamic flows", AIAA Paper 92-0439, 1992.
- [11]. Hughes T.J., "Multiscale phenomena: Green's functions, the Dirichletto-Neumann formulation, subgrid scale models, bubbles and the origins of stabilized methods", Comput Meth Appl Mech Eng, 127:387-401, 1995.
- [12]. Codina R. A., "stabilized finite element method for generalized stationary incompressible flows", Comput Meth Appl Mech Eng, 190: 2681-706, 2001.
- [13]. Houzeaux G, Codina R., "A Chimera method based on a Dirichlet/Neumann (Robin) coupling for the Navier-Stokes equations", Comput Meth Appl Mech Eng,192:3343-77, 2003.
- [14]. T.J. Barth, "Aspects on unstructured grids and finite volume solvers for the Euler and Navier-Stokes equations", AGARD report 787, VKI Special Course on Unstructured Grid Methods for Advection Dominated Flows, pp. 6.1-6.61, 1992.
- [15]. J.T. Batina, "Unsteady Euler airfoil solutions using unstructured dynamic meshes", Proc. 27th Aerospace Sciences Meeting, Reno, AIAA-89-0115, 1989.
- [16]. E. Dick, "Multigrid methods for steady Euler and Navier-Stokes equations based on polynomial flux-difference splitting", Proc. of the Third European Conference on Multigrid Methods, Bonn, International Series of Numerical Mathematics, Vol. 98, Birkhäuser, Basel, pp. 1-20, 1991.
- [17]. E. Dick, J. Linden, "A multigrid method for steady incompressible Navier-Stokes equations based on flux difference splitting, International. J. of Numerical. Methods in Fluids 14, 1311-1323, 1992.
- [18]. H. Guillard, "Node-nested multigrid with Delaunay coarsening", INRIA, 1993.
- [19]. B. Palmerio, "Coupling mesh and flow in viscous fluid calculations when using unstructured triangular finite elements", International. J. of Computational. Fluid Dynamics, 6, 275-290, 1996.
- [20]. J.Y. Trépanier, M. Reggio, M. Paraschivoiu, R. Camarero, "Unsteady Euler solutions for arbitrarily moving bodies and boundaries", AIAA 31 (10), 1869-1876, 1993.
- [21]. Takahashi,Y, "On trapping of fluid between teeth of the gear pump", (in japanese), 6(22).6-10, 1940.
- [22]. Ichikawa,T, "gear pump (in japanese)" Nikkan Kogyo Shinbunsha., p13, 1962.
- [23]. Aida,T and Terauchi,Y, "On the bending stress of spur gear (3rd report, on the calculation results of bending stress of a gear tooth)", Bull. japan Soc. Mech. Engr., 5(17).176-183, 1962.
- [24]. D. del Campo, R. Castilla, G. A. Raush, P. J. Gamez Montero and E. Codina, "Numerical Analysis of External Gear Pumps Including Cavitation", ASME J. of Fluids Engineering, 134(8), 2012.
- [25]. Karthikeyan N, Suresh Kumar J, Ganesan V, "Development of a gerotor oil pump using cfd", 4th International Conference on Fluid Mechanics and Fluid Power, December 16-18, Chennai, India, 2010.